



Comfortable indoor ventilation

Prices 2025 - Sales EMEA East

always the best climate



always the best climate

Our mission is to provide a healthy indoor climate with top quality solutions. Living spaces are kept at a comfortable temperature by our radiators and heating & cooling ceilings whereas our ventilation solutions make sure that you can breathe fresh clean air 24/7.

zehnder



Trusted partner

We provide our customers with tailored services from planning to installation of excellent solutions for the best indoor climate since 1895.



Know what's next

Consistent focus on innovation has always been the motor for our business. We strive to provide intelligent solutions for ventilation, heating, and cooling.



Swiss quality and precision

Swiss quality and precision are reflected in all our products. Our design standards create timeless elegance in living spaces for yesterday, today, and tomorrow.



Know why, know how

It is our ongoing mission to share our expertise and know how with our customers by providing expert trainings. Our dedicated Zehnder academies bring indoor climate to life.



Dr. Hans-Peter Zehnder & Milva Inderbitzin-Zehnder

From family business to international company

From a small family-run mechanical workshop in Gränichen, Switzerland, Zehnder grew into a leading international corporation. The company roots are deeply intertwined with the entrepreneurial spirit of the Zehnder family. These are visible in Zehnder's corporate culture, the customer focus, respect, trust, curiosity, and openness.

Your global partner for indoor climate

4.000
employees

16
production
plants

more than
1.400
patents and
registered designs

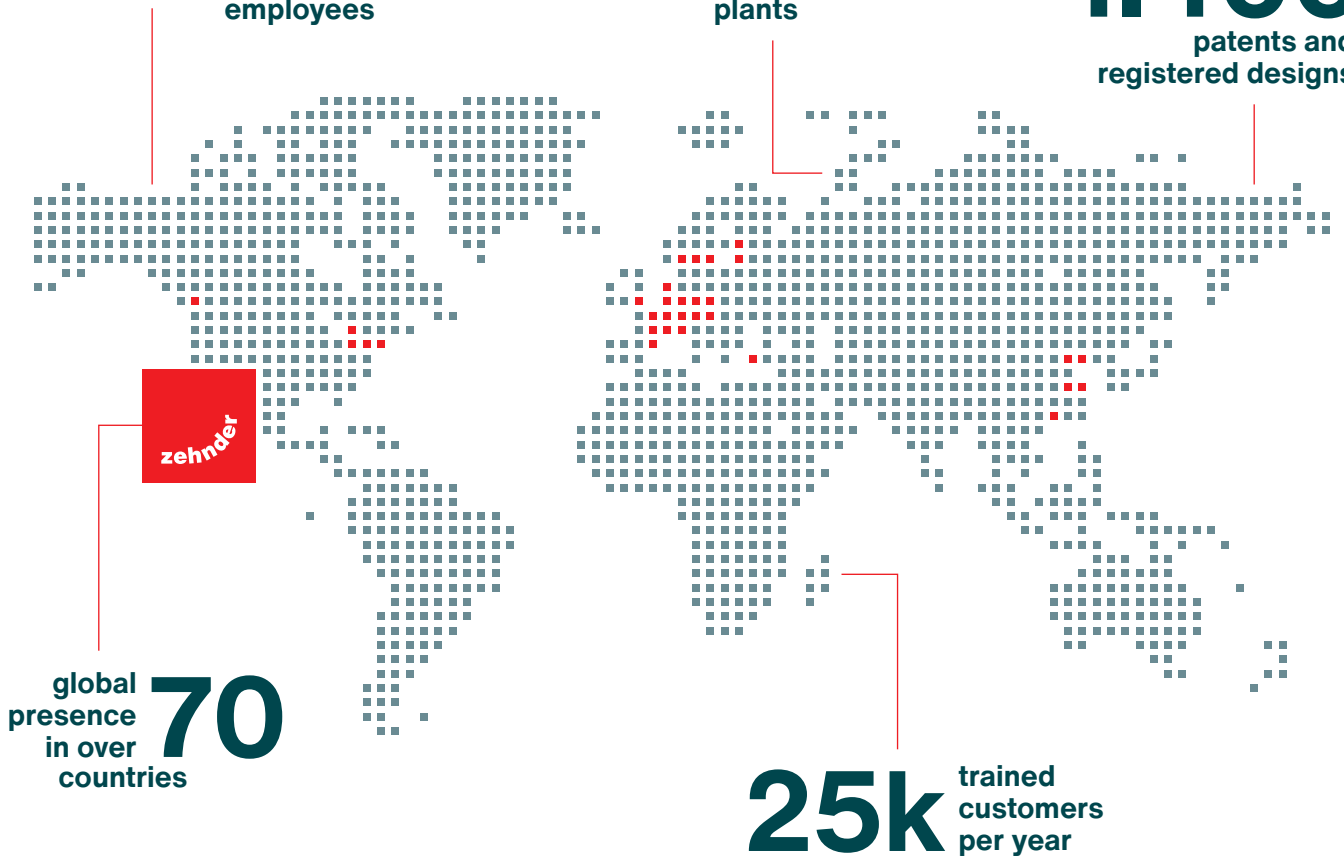

Decorative radiators

Our decorative radiators do not only make a home feel cozy but have also eye-catching designs.



Comfortable indoor ventilation

Our ventilation systems ensure a healthy indoor climate but operate with high energy efficiency, boost wellbeing, and retain the property value.



Heating and cooling ceilings

Our heating and cooling ceilings are energy efficient and versatile to fit multiple environments.



Industrial air cleaning

Our clean air solutions are transforming working environments and improving the performance of businesses everywhere.

Zehnder comfort ventilation Simple. Efficient. Smart.

Ventilation, cooling, heating and dehumidifying - your Zehnder comfort ventilation system can do it all, providing you with comfortable, healthy and energy efficient feel-good climate. The complete system offers all components from a single source. With the comprehensive product range, projects can be carried out in almost every building situation.

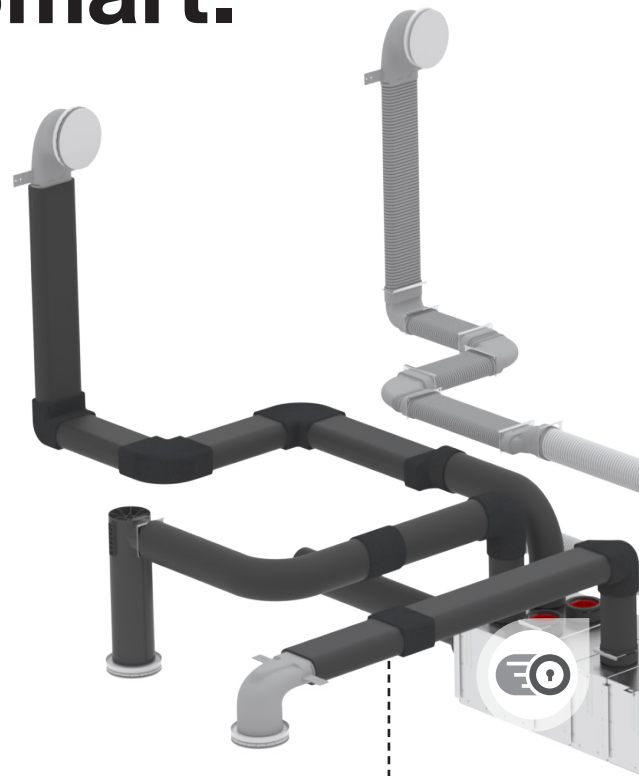

Air distribution system

With the well thought and proven Zehnder air distribution system, you are perfectly prepared for every structural condition.

Round tube, flat tube or a combination of both

Simple and time-saving mounting thanks to self explaining components and specially developed molded parts

Insulated air distribution ComfoTherm for heating and cooling applications

New connection system RapidLock® for quick and secure mounting



from page 42



Comfort ventilation units



Decentralised ventilation solutions

Central comfort ventilation units up to 600 m³/h



from page 12

General Sales and Delivery Conditions:

Our General Sales and Delivery Conditions apply.

You can find these under "Legal notice" on our homepage at www.international.zehnder-systems.com

Filters

Zehnder original filters guarantee best performance, highest possible energy efficiency as well as a hygienic and silent operation of the ventilation unit.

Filters extract pollen, spores and bacteria out of the fresh outdoor air - ideal for allergy sufferers.

from page 102



Controls & Sensors

User-friendly operation - from switches to the app

For an energy saving and demandbased system



from page 42



Connectivity

Smart control your indoor climate with our connectivity solutions:

- Voice control
- Online dashboard with system data
- Integration in BMS systems
- Remote diagnosis and maintenance



Extensions

Cooling, heating and dehumidifying:
System extensions for Zehnder ventilation units enhance comfort and energy efficiency.



Cooling unit – Air-to-air heat pump with inverter technology for air pre-treatment.

Enthalpy exchanger – regulation of humidity

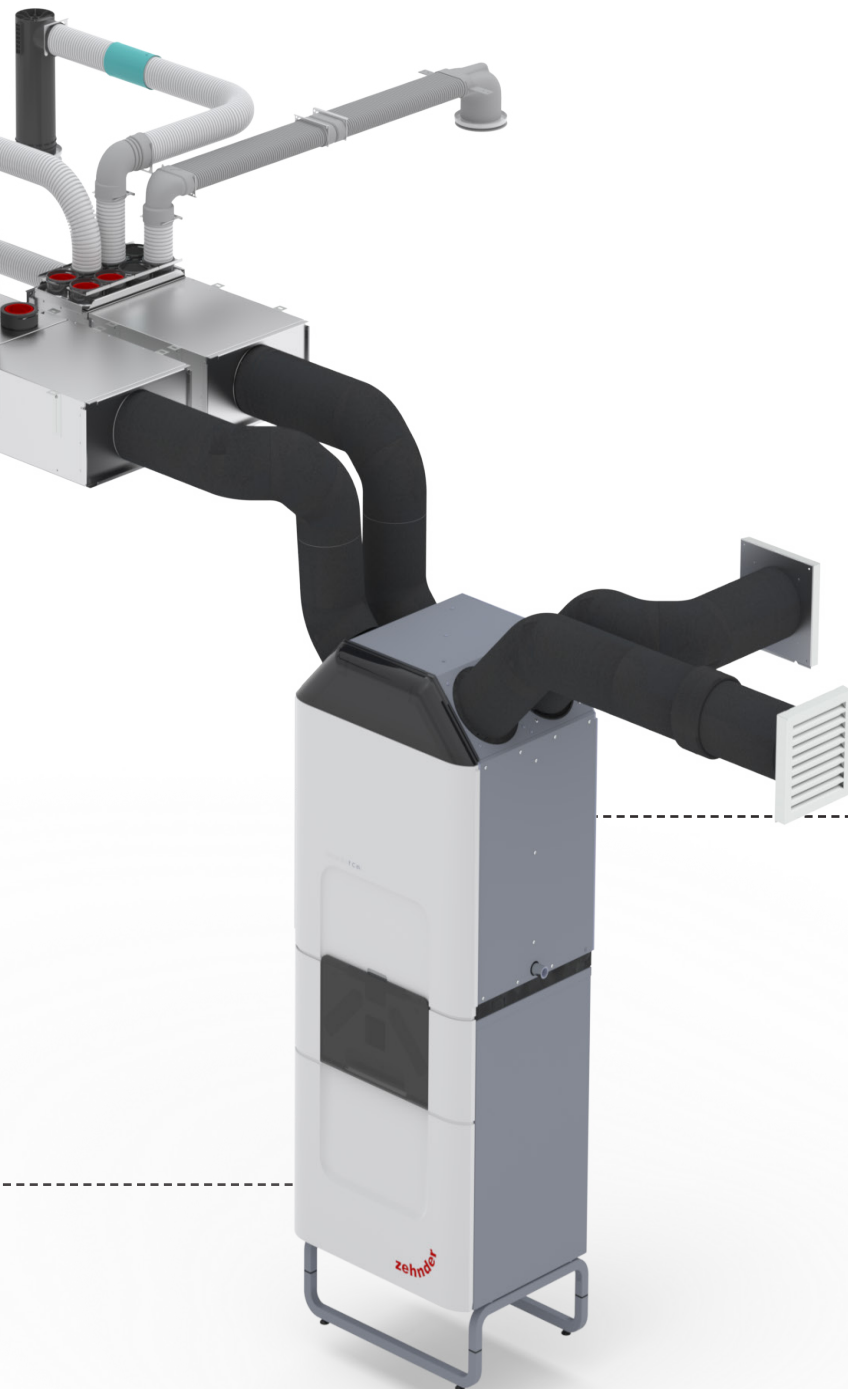



Zehnder comfort ventilation units

Page 12

Decentralised ventilation solutions
Central comfort ventilation units up to 600 m³/h
System expansions

Zehnder air distribution system

Page 42

Connection accessories for ventilation units
Silencer/manifold system
Ventilation tubes and moulded parts
Air outlets

Zehnder outdoor and exhaust air

Page 90

Brine-earth heat exchangers
Facade system
Outdoor air/exhaust air connector

Zehnder replacement filters

Page 102

Replacement filters for ventilation units
and air distribution systems



Zehnder comfort ventilation units

10 – 38



Information on filter standards	10
Information & overview of energy efficiency classes	12
Overview of comfort ventilation units	16
ComfoSpot 50 decentralised comfort ventilation unit	18
ComfoAir 70 decentralised comfort ventilation unit	20
Extract Fans	22
ComfoAir Fit 100 comfort ventilation unit	23
ComfoAir 160 comfort ventilation unit	25
ComfoAir 180 comfort ventilation unit	26
ComfoAir 200 comfort ventilation unit	27
ComfoAir Flex 250 / 350 comfort ventilation unit	29
ComfoAir Q350 TR comfort ventilation unit	31
ComfoAir Q450 TR comfort ventilation unit	31
ComfoAir Q600 ST comfort ventilation unit	32
ComfoClime 24 / 36	34
Climos 200 comfort ventilation unit	35
Focus 200 comfort ventilation unit	36
Enthalpy exchanger	37
Defroster heater, demand control	38

Be sure with Zehnder original filters to the new ISO 16890 air filter standard

Zehnder ventilation units provide rooms with a permanent supply of fresh and healthy air. The original filter in your ventilation system plays an important role here. In order to better evaluate filter performance, the standard that tests filter performance has now been adapted.

The ISO 16890 air filter standard has superseded the previous standard, EN 779, with regard to filter assessment and classification since January 2017 and comes into force in its entirety as of 1 July 2018.

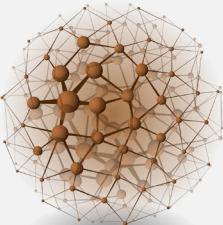
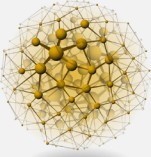
PARTICLE SIZES AND FILTER CLASSIFICATIONS

 <p>ISO Coarse > 10 µm Sand, fluff, flying seeds, fine hair etc.</p>	 <p>ISO ePM10 ≤ 10 µm Pollen, stone dust, agricultural dust etc.</p>	 <p>ISO ePM2,5 ≤ 2.5 µm Bacteria, fungi and mould spores, pollen, toner powder etc.</p>	 <p>ISO ePM1 ≤ 1 µm Viruses, bacteria, nanoparticles, soot, sea salt, oil mist etc.</p>
--	---	--	--

Diameter of a human hair: ~ 70 µm



Particle sizes and filter classification according to the new ISO 16890 air filter standard

ISO 16890 at a glance

Realistic assessment of filters

ISO 16890 replaces the EN779 standard, whereby only a single particle size of 0.4 µm was used to assess filter performance. Fine dust, such as soot or pollen, however, comes in different sizes, which are often invisible to the naked eye. ISO 16890 now divides filters into four classes that filter a certain particle span out of the air. To be assigned a category, a filter must separate at least 50% of the respective particle sizes.

New name – same high performance

With Zehnder, you can make the perfect choice for an ideal indoor climate every time. High performance is a given when it comes to the development of our original filters. Due to the perfect coordination of the ventilation system and the original filter, the required standards had already been met even before the introduction of the new ISO 16890 air filter standard. So essentially only the name of our filters has changed – but the performance is still the same.

With the ideal combination of ventilation system and original Zehnder filters, you can be assured. This means that our filter set for Zehnder ComfoAir Q, for example, is no longer called F7, but instead ISO ePM1 greater than or equal to 50%.

The energy efficiency label

The energy efficiency marking for comfort ventilation units that was introduced in January 2016 offers you and your customers more information and transparency as well as better guidance with regard to quality and efficiency. For Zehnder, the label signifies a confirmation of the high standards of energy efficiency for products and systems. It also benefits end users going forward, as they continue to choose ventilation units which combine the very best results with maximum functionality.

What is the significance of the energy efficiency label?

At a glance:



- Alphabetic classification in energy efficiency classes from A+ to G
- Parameter for specific energy consumption (SEC): annual power consumption minus annual energy saving
- Most Zehnder units for central comfort ventilation have been classified as A+.
- Airflow volume, heat and humidity recovery, fans and the control unit all affect the energy efficiency class.



The energy efficiency label

SEC class	SEC in kWh/m ² ·a
A+ (highest efficiency)	SEC < -42
A	-42 ≤ SEC < -34
B	-34 ≤ SEC < -26
C	-26 ≤ SEC < -23
D	-23 ≤ SEC < -20
E	-20 ≤ SEC < -10
F	-10 ≤ SEC < 0
G (lowest efficiency)	0 ≤ SEC

A SEC of 0 is equivalent to window ventilation. A SEC of -42 indicates primary energy savings of 42 kWh/m² a.

Overview of energy efficiency classes ¹⁾						
Decentralised ventilation unit	Page	Article number	Control according to site requirements			Manual control
			Humidity sensor board 527 007 260	Humidity and VOC sensor board 527 007 270	Humidity and CO ₂ sensor board 527 007 280	
 ComfoSpot 50	18	527 007 210 527 007 220 527 008 580 527 008 770		A		B ²⁾
 ComfoAir 70	20	527 007 230 527 007 240 527 007 250 527 008 590 527 008 780		A		A

¹⁾ Energy efficiency classes in accordance with Directive 2009/125/EC of EU Regulation no. 1253/2014

²⁾ The control is integrated in the unit

³⁾ Energy efficiency class applies in conjunction with one or two adjoining room connections. If there is no adjoining room connection, energy efficiency class B applies

Overview of energy efficiency classes ¹⁾						
Comfort ventilation unit	Page	Article number	Control according to site requirements		Manual control	
			Humidity sensor board 400 300 305	Humidity and OC2 sensor board 400 300 310		
 ComfoAir Fit 100	22	471 360 070 471 360 100 471 360 010 471 360 040		A		A

¹⁾ Energy efficiency classes according to EU Regulation No. 1254/2014

Overview of energy efficiency classes¹⁾

Comfort ventilation unit	Page	Article number	Control according to site requirements			Central demand control	Time control
			2 x CO ₂ sensors 655 000 845 / 655 000 850 / 655 000 855	CO ₂ sensor 655 000 845 / 655 000 850 / 655 000 855 and Humidity sensor 659 000 330	2 x humidity sensors 659 000 330		
 ComfoAir 160	25	471 218 210 471 218 215	A ⁺			A	A
	25	471 218 230 471 218 235	A			A	B
 ComfoAir 180	26	471 212 210 471 212 215	-			-	A
	26	471 212 230 471 212 235	-			-	A
 ComfoAir 200	27	471 222 010 471 222 015 471 222 110 471 222 115	A ⁺			A	A
	27	471 222 450 471 222 455 471 222 470 471 222 475	A			A	B

¹⁾ Energy efficiency classes in accordance with Directive 2009/125/EC of EU Regulation no. 1253/2014















Overview of energy efficiency classes¹⁾

Comfort ventilation unit		Page	Article number	Control according to site requirements	Central demand control	Time control	Manual control
				Option box ²⁾ 471 502 007 + 2 x CO ₂ sensors 655 000 845 / 655 000 850 / 655 000 855 1 x CO ₂ sensor 655 000 845 / 655 000 850 / 655 000 855 and 1 x humidity sensor 659 000 330 2 x humidity sensors 659 000 330	No further accessories	No further accessories	No further accessories
	ComfoAir Flex 250	29	471 234 190	A ⁺	A	A	A
	ComfoAir Flex 350	29	471 234 205	A ⁺	A	A	A
	ComfoAir Q350 TR	31	471 502 110	A ⁺	A ⁺	A	A
	ComfoAir Q350 TR enthalpy	31	471 502 111	A ⁺	A	A	A
	ComfoAir Q450 TR	31	471 502 112	A ⁺	A ⁺	A	A
	ComfoAir Q450 TR enthalpy	31	471 502 113	A ⁺	A	A	A
	ComfoAir Q600 ST	32	471 502 114	A ⁺	A	A	A
	ComfoAir Q600 ST enthalpy	32	471 502 115	A	A	B	B

¹⁾ Energy efficiency classes in accordance with Directive 2009/125/EC of EU Regulation no. 1253/2014

²⁾ Option Box is not combineable with ComfoAir Flex units

Overview of energy efficiency classes¹⁾

Comfort ventilation unit	Page	Article number	Control according to site requirements			Central demand control	Time control	Manual control
			2 x CO ₂ sensors 655 000 845 / 655 000 850 / 655 000 855 and expansion set 528 007 290	Humidity sensor 659 000 330 and expansion set 528 007 290	2 x humidity sensors 659 000 330 and expansion set 528 007 290			
 Climos 200 enthalpy	35	527 003 250 527 003 240 527 003 270 527 003 260						
 Focus 200	36	527 002 060 527 002 070						
 Focus 200 enthalpy	36	527 002 080 527 002 090						

¹⁾ Energy efficiency classes in accordance with Directive 2009/125/EC of EU Regulation no. 1253/2014

Overview of comfort ventilation units

	Model	Page	Air volume																
			50 (m ³ /h)	100 (m ³ /h)	150 (m ³ /h)	200 (m ³ /h)	250 (m ³ /h)	300 (m ³ /h)	350 (m ³ /h)	400 (m ³ /h)	450 (m ³ /h)	500 (m ³ /h)	550 (m ³ /h)						
Decentralised	ComfoSpot 50	18	15 – 50																
	ComfoAir 70	20	15 – 60																
Centralised	ComfoAir Fit 100	22	25 – 110																
	ComfoAir 160	25	32 – 160																
	ComfoAir 180	26	30 – 180																
	ComfoAir 200	27	50 – 200																
	Climos 200	35	50 – 200																
	Focus 200	36	45 – 200																
	ComfoAir Flex 250	29	40 – 250																
	ComfoAir Flex 350	29	40 – 350																
	ComfoAir Q350 TR	31	40 – 350																
	ComfoAir Q450 TR	31	50 – 450																
	ComfoAir Q600 ST	32	60 – 600																

Maximum air volume range

Recommended air volume range for normal ventilation level according to DIN 1946-6

Dimensions / weight				Installation			Nominal connection size	Unit version	
Length (mm)	Height (mm)	Depth (mm)	Weight from (kg)	Wall	Ceiling	Floor-mounted with base	DN / mm	Supply air, left	Supply air, right
380 ¹⁾	376 ¹⁾	50 ¹⁾	6	•					
440 ¹⁾	660 ¹⁾	145 ¹⁾	22	•			90 mm		
821	465	216	18	•	•		DN 125		
670	864	268	30	•	•		DN 125		
558	680	299	22	•			DN 125		
544	1200	324	30	•	•		DN 125		
594	1019	250	25	•	•		DN 125		
752	565	362	25	•		•	DN 125		
960	1110	350	45		•		DN 160		
960	1110	350	45		•		DN 160		
775	850	570	50	•		•	DN 160		
775	850	570	50	•		•	DN 160		
725	850	570	50	•		•	DN 180		

¹⁾ Dimensions of interior wall panel

²⁾ Delivered as right-hand unit; converted to left-hand unit on-site

³⁾ Turn the unit to change it to the left-hand or right-hand version

ODA = outdoor air, ETA = extract air, EHA = exhaust air, SUP = supply air

ComfoSpot decentralised ventilation unit

Product	Description	PU 1	PU 2	Article no.	Gross price €	Discount group
ComfoSpot 50						
  Passive house certified	ComfoSpot 50 comfort ventilation unit 50 m ³ /h airflow volume, cross-counterflow enthalpy exchanger with humidity recovery, for installation in outside wall, with built-in control panel, without wall mounting tube. A wall mounting tube is required for wall installation. As an option, sensor boards for measuring humidity, VOC and CO ₂ and/or an external control panel can be installed (accessories) Dimensions: Inside wall panel: 380 x 376 x 50 mm (W x H x D) Outside wall panel: 380 x 376 x 50 mm (W x H x D)					
	ComfoSpot 50 comfort ventilation unit Plastic outside wall panel, without wall mounting tube CSP50-PRM-FRT-PLS	1	9	 527 007 210	1.130,50	C
	ComfoSpot 50 comfort ventilation unit Stainless steel outside wall panel, without wall mounting tube CSP50-PRM-FRT-SST	1	9	 527 007 220	1.320,30	C
	ComfoSpot 50 comfort ventilation unit 50m ³ /h airflow volume, cross-counterflow enthalpy heat exchanger with humidity recovery, for installation in the outside wall, with built-in humidity sensor board, control panel and plastic outside wall panel, without wall mounting tube. For wall mounting a wall mounting tube is necessary. Optionally an external control panel can be installed (accessory part). CSP50-PRM-RH-FRT-PLS	1	-	 527 008 770	1.284,00	C
	ComfoSpot 50 comfort ventilation unit 50m ³ /h airflow volume, cross-counterflow enthalpy heat exchanger with humidity recovery, for installation with window reveal module, with built-in control panel and plastic inside wall panel, without outside wall panel. Optionally sensor boards for humidity, VOC-, CO ₂ - measuring and/or an external control panel can be installed (accessory parts) CSP50-PRM	1	-	 527 008 580	1.089,10	C
	Window reveal module for ComfoSpot 50 consisting of switching unit with solid-state round wall mounting pipe (length= 580 mm) and plugs, 2 flat ducts each à 2040 x 300 mm with seals, 2 flat ducts insulation elements, duct adapter and external wall grille CON-RVL-CSP50	1	-	527 008 660	526,00	C
ComfoSpot 50 accessories						
	ComfoLED control panel for ComfoSpot 50 and ComfoAir 70 Interface made from acrylic glass, for standard cover frame (cut-out 55 x 55 mm) WR-CSP50-CA70-PCK	1	50	527 007 290	109,00	C

* Energy efficiency class applies in conjunction with one sensor; see overview of energy efficiency classes.

ComfoSpot decentralised ventilation unit

Product	Description	PU 1	PU 2	Article no.	Gross price €	Discount group
ComfoSpot 50 accessories						
	ComfoRF module for ComfoSpot 50 and ComfoAir 70 Radio frequency module for decentral app-controlling KIT-RF-MOD	1	-	527 010 550	145,30	C
	ConnectBox for ComfoSpot 50 and ComfoAir 70 ConnectBox for decentral app-controlling KIT-CNB	1	-	527 010 580	362,20	C
	Humidity sensor board for ComfoSpot 50 and ComfoAir 70 Sensor board for connection in the unit KIT-SNS-MOD-RH-PCK	1	-	527 007 260	85,80	C
	Humidity and VOC sensor board for ComfoSpot 50 and ComfoAir 70 Sensor board for connection in the unit KIT-SNS-MOD-VOC-PCK	1	-	527 007 270	225,20	C
	Humidity and CO ₂ sensor board for ComfoSpot 50 and ComfoAir 70 Sensor board for connection in the unit KIT-SNS-MOD-CO2-PCK	1	-	527 007 280	341,90	C
	Round wall mounting tube made from plastic, Ø 315 mm, with 2 blanking plugs, for retrofitting length = 600 mm MAC-CSP50-PIP-DN315-D600-PLS	1	16	527 005 440	113,10	C
	length = 900 mm MAC-CSP50-PIP-DN315-D900-PLS	1	-	527 009 130	126,50	C
	Square wall mounting tube made from EPP, 360 x 360 (W x H), length = 600 mm, with 2 blanking plugs, for new builds MAC-CSP50-DCT-W360-H360-D600-EPP	1	9	527 005 450	231,50	C
	Extension set for ComfoSpot 50 made of EPP, with 2 plugs, outside diameter 315 mm, length = 285 mm. For wall thickness greater than 600 mm, in combination with round wall mounting tube length = 900 mm SET-EXT-CSP50	1	-	527 009 150	148,10	C
	Filter set for ComfoSpot 50, ISO Coarse ≥ 70 % (G4) 2 pieces FIL-CSP50-CRS/G4-2PC-PCK	1	-	527 005 390	28,21	B
	Filter set for ComfoSpot 50, ISO Coarse ≥ 70 % / ISO ePM10 ≥ 60 % (G4 / F7) 2 pieces FIL-CSP50-CRS/G4-ePM10/F7-2PC-PCK	1	-	527 005 400	30,81	B
	Filter set for ComfoSpot 50, ISO Coarse ≥ 70 % (G4) 10 pieces FIL-CSP50-CRS/G4-10PC-PCK	1	-	527 005 410	118,60	B
	Filter set for ComfoSpot 50, ISO Coarse ≥ 70 % / ISO ePM10 ≥ 60 % (G4 / F7) 10 pieces FIL-CSP50-CRS/G4-ePM10/F7-10PC	1	-	527 005 420	130,10	B

ComfoAir decentralised ventilation unit





Product	Description	PU 1	PU 2	Article no.	Gross price €	Discount group
ComfoAir 70						
  	<p>ComfoAir 70 comfort ventilation unit 60 m³/h (50 Pa) airflow volume, cross-counterflow enthalpy exchanger with humidity recovery, for installation on the inside of outside walls, with connections for ventilation ducts to supply and extract from adjoining rooms, with built-in control panel, without wall mounting tube.</p> <p>Supply connector on rear or side (right) DN 100, Extract air connector on rear or side (left) DN 100</p> <p>As an option, sensor boards for measuring humidity, VOC and CO₂ and/or an external control panel can be installed (accessories)</p> <p>Dimensions: Inside wall panel: 440 x 660 x 145 mm (W x H x D) Outside wall panel: 380 x 376 x 50 mm (W x H x D)</p>					
	<p>ComfoAir 70 comfort ventilation unit White aluminium outside wall panel, without wall mounting tube CA70-PRM-ALU</p>	1	4	527 007 230	1.697,10	C
	<p>ComfoAir 70 comfort ventilation unit Plastic outside wall panel, without wall mounting tube CA70-PRM-FRT-PLS</p>	1	4	527 007 240	1.586,70	C
	<p>ComfoAir 70 comfort ventilation unit Stainless steel outside wall panel, without wall mounting tube CA70-PRM-FRT-SST</p>	1	4	527 007 250	1.775,30	C
	<p>ComfoAir 70 comfort ventilation unit 60m³/h (50 Pa) airflow volume, cross-counterflow enthalpy heat exchanger with humidity recovery, for installation in the inside of the outside wall, with connections for ventilation ducts to supply and extract adjoining rooms with built-in humidity sensor board, control panel and plastic outside wall panel, without wall mounting tube.</p> <p>Supply connector on rear or side (right) DN 100, Extract Air connector on rear or side (left) DN 100.</p> <p>Optionally an external control panel can be installed (accessory part). CA70-PRM-RH-FRT-PLS</p>	1	-	527 008 780	1.704,90	C
	<p>ComfoAir 70 comfort ventilation unit 60m³/h (50 Pa) airflow volume, cross-counterflow enthalpy heat exchanger with humidity recovery, for installation with window reveal module, with connections for ventilation ducts to supply and extract adjoining rooms, with built-in control panel and plastic inside wall panel, without outside wall panel and wall mounting tube.</p> <p>Optionally sensor boards for humidity, VOC-, CO₂- measuring and/or an external control panel can be installed (accessory parts) CA70-PRM</p>	1	-	527 008 590	1.538,40	C
	<p>Window reveal module for ComfoAir 70 consisting of switching unit with solid-state round wall mounting tube (length = 580 mm) and plugs, 2 flat ducts each à 2040 x 300 mm with seals, 4 flat ducts insulation elements, 2 duct adapters and 2 external wall grilles CON-RVL-CA70</p>	1	-	527 008 670	526,00	C
ComfoAir 70 accessories						
	<p>ComfoLED control panel for ComfoSpot 50 and ComfoAir 70 Interface made from acrylic glass, for standard cover frame (cut-out 55 x 55 mm) WR-CSP50-CA70-PCK</p>	1	50	527 007 290	109,00	C

* Energy efficiency class applies in conjunction with one sensor; see overview of energy efficiency classes.

ComfoAir decentralised ventilation unitt



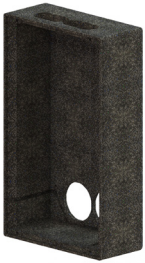

Product	Description	PU 1	PU 2	Article no.	Gross price €	Discount group
ComfoAir 70 accessories						
	ComfoRF module for ComfoSpot 50 and ComfoAir 70 Radio frequency module for decentral app-controlling KIT-RF-MOD	1	-	527 010 550	145,30	C
	ConnectBox for ComfoSpot 50 and ComfoAir 70 ConnectBox for decentral app-controlling KIT-CNB	1	-	527 010 580	362,20	C
	Humidity sensor board for ComfoSpot 50 and ComfoAir 70 Sensor board for connection in the unit KIT-SNS-MOD-RH-PCK	1	-	527 007 260	85,80	C
	Humidity and VOC sensor board for ComfoSpot 50 and ComfoAir 70 Sensor board for connection in the unit KIT-SNS-MOD-VOC-PCK	1	-	527 007 270	225,20	C
	Humidity and CO ₂ sensor board for ComfoSpot 50 and ComfoAir 70 Sensor board for connection in the unit KIT-SNS-MOD-CO2-PCK	1	-	527 007 280	341,90	C
	Round wall mounting tube made from plastic, Ø 250 mm, with 2 blanking plugs, for retrofitting length = 600 mm MAC-CA70-PIP-DN250-D600-PLS	1	16	527 005 200	98,90	C
	length = 900 mm MAC-CA70-PIP-DN250-D900-PLS	1	-	527 009 120	121,10	C
	Square wall mounting tube made from EPP, 268 x 268 (W x H), length = 600 mm, with 2 blanking plugs, for new builds MAC-CA70-DCT-W268-H268-D600-EPP	1	6	527 005 800	217,70	C
	Extension set for ComfoAir 70 made of EPP, with 2 plugs, outside diameter 250 mm, length = 285 mm. For wall thickness greater than 600 mm, in combination with round wall mounting tube length = 900 mm SET-EXT-CSP70	1	-	527 009 140	190,50	C
	Filter set for ComfoAir 70, ISO Coarse ≥ 70 % (G4) 2 pieces FIL-CA70-CRS/G4-2PC-PCK	1	-	527 005 180	30,98	B
	Filter set for ComfoAir 70, ISO Coarse ≥ 70 % / ISO ePM10 ≥ 60 % (G4 / F7) 2 pieces FIL-CA70-CRS/G4-ePM10/F7-2PC-PCK	1	-	527 005 190	34,15	B
	Filter set for ComfoAir 70, ISO Coarse ≥ 70 % (G4) 10 pieces FIL-CA70-CRS/G4-10PC	1	-	527 005 160	128,60	B
	Filter set for ComfoAir 70, ISO Coarse ≥ 70 % / ISO ePM10 ≥ 60 % (G4 / F7) 10 pieces FIL-CA70-CRS/G4-ePM10/F7-10PC	1	-	527 005 170	138,20	B
	Sealing tape for ComfoAir 70 1 piece for twin-room connection SEL-PRF-SAD-W9.5-L1000-0049-PCK	1	10	521 000 580	7,90	B

ComfoAir ventilation units





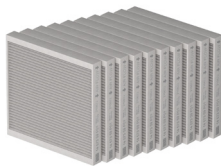

Product	Description	PU 1	PU 2	Article no.	Gross price €	Discount group
ComfoAir Fit 100						
 <p>NEW</p> <p>Passive house certified</p> 	ComfoAir Fit 100 comfort ventilation unit 110 m ³ /h (80 Pa) air volume flow, cross-counterflow heat exchanger, wallmounted or floor- or ceiling mounting possibilities, with three-stage switch, without condensate drain			A⁺ *		
	ComfoAir Fit 100 SL Enthalpy straight with supply air connector, left CAFT100-L-STT	1	6	471 360 070	1.900,00	CQ
	ComfoAir Fit 100 RL Enthalpy straight with supply air connector, right CAFT100-R-STT	1	6	471 360 100	1.900,00	CQ
	ComfoAir Fit 100 CL Enthalpy corner with supply air connector, left CAFT100-L-CNR	1	6	471 360 010	1.900,00	CQ
	ComfoAir Fit 100 SR Enthalpy corner with supply air connector, right CAFT100-L-STT	1	6	471 360 040	1.900,00	CQ
ComfoAir Fit 100- flush-mounting box & design cover						
 <p>NEW</p>	ComfoAir Fit 100 flush-mounting box The flush-mounting box can be installed in the building envelope prior to the unit HSG-CCM-CAFT100	1	-	990 800 000	280,00	C
 <p>NEW</p>	ComfoAir Fit 100 design cover Design cover for harmonious integration to interior design. Can be painted with standard wall paint DSG-COV-HSG-CCm-CAFT100	1	-	990 800 001	140,00	C

* Energy efficiency classes in accordance with EU Regulation no. 1254/2014.n The energy efficiency class applied when the unit is used with manual control. Further information is available at www.international.zehnder-systems.com

ComfoAir ventilation units

Product	Description	PU 1	PU 2	Article no.	Gross price €	Discount group
ComfoAir Fit 100 accessories						
	ComfoLED control panel Interface made from acrylic glass, for standard cover frame (cut-out 55 x 55 mm) WR-CSP50-CA70-FRA-PCK	1	50	528 009 050	127,50	C
	Installation set, wall-integrated WR-CSP50-CA70-FRA-PCK	1	-	990 800 002	11,20	C
	Installation set, wall-mounted or ceiling KIT-MAC-CAFT100-CCO	1	-	990 800 003	38,00	C
	Humidity sensor board for ComfoAir Fit 100 Sensor board for connection in the unit KIT-CAFT100-SNS-MOD-RH-PCK	1	-	400 330 017	85,50	C
	Humidity & CO2 sensor board for ComfoAir Fit 100 Sensor board for connection in the unit KIT-CAFT100-SNS-MOD-CO2-PCK	1	-	400 330 016	341,90	C
	Filter set for ComfoAir Fit 100 ISO Coarse ≥ 65% (G4) 2 pieces FIL-CAFT100-SET-CRS/CRS-2PC-PCK	1	-	400 100 170	38,10	C
	IHygiene filter set for ComfoAir Fit 100 ISO Coarse ≥ 65% (G4) / ISO ePM1 ≥ 55% (F7) 2 pieces FIL-CAFT100-SET-CRS/ePM1-2PC-PCK	1	-	400 100 180	43,50	C
	Filter set for ComfoAir Fit 100 ISO Coarse ≥ 65% (G4) 10 pieces FIL-CAFT100-SET-CRS/CRS-10PC-PCK			400 100 175	150,00	C

Extract Fans

Product	Description	PU 1	PU 2	Article no.	Gross price €	Discount group
Zehnder Silent						
	Axial fan	1	-	ZSR100B	68,10	77
	SR100 mm basic - in carton	1	-	ZSR100TR	77,90	77
	SR100 mm timer - in carton	1	-	ZSR100HTR	94,20	77
	Shower kit	1	-	ZSR100LTSK	148,40	77
	100 mm shower kit with 12 V SELV light - timer - white and chrome grille					
Zehnder Samika						
	Adaptive fan 100 mm low watt adaptive fan with SMART humidistat & timer	1	-	ZLE100HT	217,40	77
Zehnder Unity ZCV2						
	Continuously running bathroom and kitchen fan 100 mm mixed flow extract fan with SMART HT which can be applied to all wet rooms including kitchen, bathroom, utility and WCs. With ultra-low energy DC motor, CE marked, CommissionSMART, TimerSMART, IPX5 for walls, IPX4 for ceilings	1	-	ZCV2	259,70	77
Zehnder Unity ZCV3						
 	Low energy continuously running bathroom and kitchen fan 100 mm mixed flow low energy fan, one solution for bathroom, kitchens, utility rooms and WCs. Connect SMART contactless technology for simple set up, customisation and data logging, CE marked, do not disturb technology, SMART Humidity sensing, SMART overrun timer, IPX5 for walls, IPX4 for ceilings	1	-	ZCV3si	296,60	77













ComfoAir ventilation units

Product	Description	PU 1	PU 2	Article no.	Gross price €	Discount group
ComfoAir 160						
  Passive house PHC certified	ComfoAir 160 comfort ventilation unit 160 m ³ /h (100 Pa) airflow volume, cross-counterflow heat exchanger with automatic summer bypass 100%, constant volume regulation, for wall and ceiling installation, without control panel. Dimensions: 670 x 864 x 268 mm (W x H x D) CA160-BS-ND-DE-MCF	1	6	 471 218 210	3.111,40	C
	ComfoAir 160 V comfort ventilation unit 160 m ³ /h (100 Pa) airflow volume, cross-counterflow heat exchanger with automatic summer bypass 100%, constant volume regulation, with pre-heater, for wall and ceiling installation, without control panel. Dimensions: 670 x 864 x 268 mm (W x H x D) CA160-BS-PRH-ND-DE-MCF	1	6	 471 218 215	3.578,30	C
	ComfoAir 160 enthalpy comfort ventilation unit 160 m ³ /h (100 Pa) airflow volume, cross-counterflow enthalpy exchanger with humidity recovery and automatic summer bypass 100%, constant volume regulation, for wall and ceiling installation, without control panel. Dimensions: 670 x 864 x 268 mm (W x H x D) CA160-BS-ERV-ND-DE-MCF	1	6	 471 218 230	4.097,10	C
	ComfoAir 160 V enthalpy comfort ventilation unit 160 m ³ /h (100 Pa) airflow volume, cross-counterflow enthalpy exchanger, with humidity recovery and automatic summer bypass 100%, with pre-heater, constant volume regulation, for wall and ceiling mounting, without control panel. Dimensions: 670 x 864 x 268 mm (W x H x D) CA160-BS-ERV-PRH-ND-DE-MCF	1	6	 471 218 235	4.562,50	C
For unit connection options, see page 42						
ComfoAir 160 accessories						
	ComfoSense 55 control panel for ComfoAir 160, 180, 200, 350 and 550 suitable for installation into Jung, Gira and Busch-Jaeger switch ranges. Including 2 covers in RAL 9016 and 2 covers in RAL 9001 CU-CFS55-9001/9016	1	30	655 010 200	321,00	C
	ComfoSense 67 control panel for ComfoAir 160, 180, 200, 350 and 550 Including cover frame, cover and surface-mounted housing in RAL 9016 CU-CFS67-HSG-9016	1	30	655 010 215	329,40	C
	Remote-controlled control panel as an additional handset for the Sense control panel CU-RF-Z1	1	-	655 000 755	141,00	C
	Condensate drain accessory for ceiling mounting COD-CA160	1	-	990 202 050	106,90	B
	Dry siphon set for ComfoAir 160, 180, 200 made from white HDPE plastic, variable wastewater connection, closed on suction side SIP-CA160/180/200	1	20	990 201 331	108,10	C
	Filter set for ComfoAir 160, ISO Coarse ≥ 65 % (G4) 2 pieces FIL-CA160-SET-CRS/CRS	1	-	400 100 023	40,04	B
	Filter set for ComfoAir 160, ISO Coarse ≥ 65 % / ISO ePM1 ≥ 65 % (G4 / F7) 2 pieces FIL-CA160-SET-CRS/ePM1	1	-	400 100 024	42,52	B

* Energy efficiency class applies in conjunction with two sensors; see overview of energy efficiency classes.

** Energy efficiency class applies in conjunction with one sensor; see overview of energy efficiency classes.

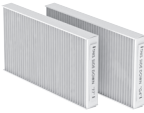
ComfoAir ventilation units





Product	Description	PU 1	PU 2	Article no.	Gross price €	Discount group
ComfoAir 180						
  <p>Passive house certified</p> <p>Unit can also be combined with standard Zehnder components.</p>	ComfoAir 180 comfort ventilation unit 180 m ³ /h (170 Pa) airflow volume, cross-counterflow heat exchanger with automatic summer bypass 100%, for wall mounting, including wall plate, four connections upwards, alternative supply air connection downwards, without control panel. Dimensions: 558 x 680 x 299 mm (W x H x D) CA180-ND-DE-MCF	1	6	 471 212 210	2.260,04	C
	ComfoAir 180 V comfort ventilation unit 180 m ³ /h (170 Pa) airflow volume, cross-counterflow heat exchanger with automatic summer bypass 100%, for wall installation, including wall plate, four connectors upwards or supply connector downwards, without control panel, with pre-heater. Dimensions: 558 x 680 x 299 mm (W x H x D) CA180-PRH-ND-DE-MCF	1	6	 471 212 215	2.589,58	C
	ComfoAir 180 enthalpy comfort ventilation unit 180 m ³ /h (170 Pa) airflow volume, cross-counterflow enthalpy exchanger with humidity recovery and automatic summer bypass 100%, for wall mounting, including wall plate, four connections upwards, alternative supply air connection downwards, without control panel. Dimensions: 558 x 680 x 299 mm (W x H x D) CA180-ERV-ND-DE-MCF	1	6	 471 212 230	3.048,23	C
	ComfoAir 180 V enthalpy comfort ventilation unit 180 m ³ /h (170 Pa) airflow volume, cross-counterflow enthalpy exchanger with humidity recovery and automatic summer bypass 100%, for wall installation, including wall plate, four connectors upwards or supply connector downwards, without control panel, with pre-heater. Dimensions: 558 x 680 x 299 mm (W x H x D) CA180-ERV-PRH-ND-DE-MCF	1	6	 471 212 235	3.399,46	C
ComfoAir 180 accessories						
      	ComfoSense 55 control panel for ComfoAir 160, 180, 200, 350 and 550 suitable for installation into Jung, Gira and Busch-Jaeger switch ranges. Including 2 covers in RAL 9016 and 2 covers in RAL 9001 CU-CFS55-9001/9016	1	30	655 010 200	321,00	C
	ComfoSense 67 control panel for ComfoAir 160, 180, 200, 350 and 550 Including cover frame, cover and surface-mounted housing in RAL 9016 CU-CFS67-HSG-9016	1	30	655 010 215	329,40	C
	Remote-controlled control panel as an additional handset for the Sense control panel CU-RF-Z1	1	-	655 000 755	141,00	C
	Dry siphon 5/4" for ComfoAir 180 SIP-5/4"-CA350/550-CF-L	1	-	990 201 330	64,00	C
	Dry siphon set for ComfoAir 160, 180, 200 made from white HDPE plastic, variable wastewater connection, closed on suction side SIP-CA160/180/200	1	20	990 201 331	108,10	C
	Filter set for ComfoAir 180, ISO Coarse ≥ 65 % (G4) 2 pieces FIL-CA180-SET-CRS/CRS	1	-	400 100 090	40,33	B
	Filter set for ComfoAir 180, ISO Coarse ≥ 65 % / ISO ePM1 ≥ 55 % (G4 / F7) 2 pieces FIL-SET-CA180-SET-CRS/EPM1	1	-	400 100 091	43,79	B

* Energy efficiency class applies in conjunction with a time control; see overview of energy efficiency classes.

ComfoAir ventilation units

Product	Description	PU 1	PU 2	Article no.	Gross price €	Discount group
ComfoAir 180 accessories						
	ComfoPipe Plus connection box DN 125 for vertical connection of ComfoAir 180 to ComfoPipe 125, material EPP, with unit connection element	1	8	990 328 804	61,04	C

Product	Description	PU 1	PU 2	Article no.	Gross price €	Discount group
---------	-------------	------	------	-------------	---------------	----------------

ComfoAir 200						
	ComfoAir 200 Luxe comfort ventilation unit 200 m ³ /h (200 Pa) airflow volume, cross-counterflow heat exchanger with automatic summer bypass 100%, for wall and ceiling installation, without control panel. Dimensions: 544 x 1200 x 324 mm (W x H x D)					
	ComfoAir 200 L Luxe with left supply connector CA200-L-LX-ND-EXP-MCF	1	3	471 222 010	3.137,50	C
	ComfoAir 200 R Luxe with right supply connector CA200-R-LX-ND-MCF	1	3	471 222 015	3.137,50	C
	ComfoAir 200 V Luxe comfort ventilation unit 200 m ³ /h (200 Pa) airflow volume, cross-counterflow heat exchanger with automatic summer bypass 100%, with pre-heater, for wall and ceiling mounting, without control panel. Dimensions: 544 x 1200 x 324 mm (W x H x D)					
	ComfoAir 200 VL Luxe with left supply connector CA200-L-LX-PRH-ND-DE-MCF	1	3	471 222 110	3.612,40	C
	ComfoAir 200 VR Luxe with right supply connector CA200-R-LX-PRH-ND-DE-MCF	1	3	471 222 115	3.612,40	C
	ComfoAir 200 Luxe enthalpy comfort ventilation unit 200 m ³ /h (200 Pa) airflow volume, cross-counterflow enthalpy exchanger, with humidity recovery and automatic summer bypass 100%, for wall and ceiling mounting, without control panel. Dimensions: 544 x 1200 x 324 mm (W x H x D)					
	ComfoAir 200 L Luxe enthalpy with left supply connector CA200-L-LX-ERV-ND-DE-MCF	1	3	471 222 450	4.600,80	C
	ComfoAir 200 R Luxe enthalpy with right supply connector CA200-R-LX-ERV-ND-DE-MCF	1	3	471 222 455	4.600,80	C
	ComfoAir 200 V Luxe enthalpy comfort ventilation unit 200 m ³ /h (200 Pa) airflow volume, cross-counterflow enthalpy exchanger, with humidity recovery and automatic summer bypass 100%, with pre-heater, for wall and ceiling mounting, without control panel. Dimensions: 544 x 1200 x 324 mm (W x H x D)					
ComfoAir 200 VL Luxe enthalpy with left supply connector CA200-L-LX-ERV-PRH-ND-DE-MCF	1	3	471 222 470	5.078,60	C	
ComfoAir 200 VR Luxe enthalpy with right supply connector CA200-R-LX-ERV-PRH-ND-DE-MCF	1	3	471 222 475	5.078,60	C	







For unit connection options, see page 42



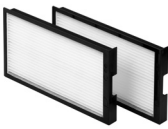
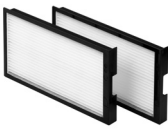

* Energy efficiency class applies in conjunction with two sensors; see overview of energy efficiency classes.

** Energy efficiency class applies in conjunction with one sensor; see overview of energy efficiency classes.

ComfoAir ventilation units

Product	Description	PU 1	PU 2	Article no.	Gross price €	Discount group
ComfoAir 200 accessories						
	ComfoSense 55 control panel for ComfoAir 160, 180, 200, 350 and 550 suitable for installation into Jung, Gira and Busch-Jaeger switch ranges. Including 2 covers in RAL 9016 and 2 covers in RAL 9001 CU-CFS55-9001/9016	1	30	655 010 200	321,00	C
	ComfoSense 67 control panel for ComfoAir 160, 180, 200, 350 and 550 Including cover frame, cover and surface-mounted housing in RAL 9016 CU-CFS67-HSG-9016	1	30	655 010 215	329,40	C
	Remote-controlled control panel as an additional handset for the Sense control panel CU-RF-Z1	1	-	655 000 755	141,00	C
	Dry siphon set for ComfoAir 160, 180, 200 made from white HDPE plastic, variable wastewater connection, closed on suction side SIP-CA160/180/200	1	20	990 201 331	108,10	C
	Filter set for ComfoAir 200, ISO Coarse $\geq 65\%$ (G4) 2 pieces FIL-PFR-L292-W24-H150-CRS-2pc	1	-	400 100 014	42,63	B
	Filter set for ComfoAir 200, ISO Coarse $\geq 65\%$ / ISO ePM1 $\geq 55\%$ (G4 / F7) 2 pieces FIL-PFR-L292-W24-H150-SET-CRS/ePM1	1	-	400 100 013	46,10	B

ComfoAir ventilation units



Product	Description	PU 1	PU 2	Article no.	Gross price €	Discount group
ComfoAir Flex						
	ComfoAir Flex 250 HRV 250 m ³ /h (200 Pa) air flow volume, cross counterflow heat exchanger, balanced ventilation unit designed for ceiling mounting. 2-in-1 unit (left/right orientation adjustable via software), low power consumption Dimensions: 1070 x 870 x 327 (W x H x D)					
	ComfoAir Flex 250 HRV CAF250-HRV-SI	1	-	471 234 190	3.611,50	CF
 Passive house certified*	ComfoAir Flex 350 HRV 350 m ³ /h (200 Pa) air flow volume, cross counterflow heat exchanger, balanced ventilation unit designed for ceiling mounting. 2-in-1 unit (left/right orientation adjustable via software), low power consumption Dimensions: 1070 x 870 x 327 (W x H x D)					
	ComfoAir Flex 350 HRV CAF350-HRV-SI	1	-	471 234 205	3.780,80	CF





ComfoAir ventilation units

Product	Description	PU 1	PU 2	Article no.	Gross price €	Discount group
ComfoAir Flex 250/350 accessories						
	ComfoSwitch C55 control panel suitable for installing in Jung, Gira and Busch-Jaeger switch ranges, including 2 covers in RAL 9016 and 2 covers in RAL 9001 SW-CNT55	1	-	655 010 245	148,20	C
	ComfoSwitch C67 control panel incl. cover frame, cover and surface-mounted housing in RAL 9016 SW-CNT67-MAC	1	-	655 010 255	157,90	C
	Remote-controlled control panel as an additional handset for the ComfoSense C control panel CU-RF-Z1	1	-	655 000 755	141,00	C
	CO ₂ -Sensor C55, 55 mm for In-wall installation, suitable with most cover frames (not included), direct connection via ComfoNet SNS-CO2-55C	1	-	655 000 885	227,54	C
	CO ₂ -Sensor C67, 67 mm for In-wall installation, cover frame in scope of delivery, direct connection via ComfoNet SNS-CO2-67C	1	-	655 000 880	227,54	C
	CO ₂ -Sensor C67, 67 mm for On-wall installation, on-wall socket and cover frame in scope of delivery, direct connection via ComfoNet SNS-CO2-67C-MTB	1	-	655 000 875	227,54	C
	CO ₂ -Sensor V55, 55 mm for In-wall installation, suitable with most cover frames (not included) SNS-CO2-V55	1	-	655 000 845	180,58	C
	CO ₂ -Sensor V67, 67 mm for In-wall installation, cover frame in scope of delivery CO2-SENSOR-0-10V-67	1	-	655 000 850	180,58	C
	CO ₂ -Sensor V67, 67 mm for On-wall installation, on-wall socket and cover frame in scope of delivery CO2-SENSOR-0-10V-67-ON-WALL	1	-	655 000 855	180,58	C
	ComfoAir RF PCB PCB-RF-CAQ/CAF	1	-	400 502 016	97,60	C
	ComfoAir Flex 250 / 350 pre-heater to increase the outdoor air temperature in winter (heat exchanger frost protection) PRH-CAF-PCK	1	-	400 300 105	522,46	C
	Filter set for ComfoAir Flex 250 / 350, ISO Coarse ≥ 65 % / ISO ePM1 ≥ 65 % (G4 / F7) FIL-CAF-ePM1/CRS	1	-	400 100 121	46,10	B
	Filter set for ComfoAir Flex 250 / 350, ISO Coarse ≥ 65 % (G4), 2 pieces FIL-CAF-CRS-2PC	1	-	400 100 122	43,79	B
	Filter set for ComfoAir Flex 250 / 350, ISO Coarse ≥ 65 % / ISO ePM1 ≥ 65 % (G4 / F7), 5 pieces FIL-CAF-ePM1-CRS-5PC	1	-	400 100 123	207,51	B
	Filter set for ComfoAir Flex 250 / 350, ISO ePM1 ≥ 65 % (F7) 10 pieces FIL-CAF-ePM1-10PC	1	-	400 100 124	217,74	B
	Filter set for ComfoAir Flex 250 / 350, ISO Coarse ≥ 65 % (G4) 10 pieces FIL-CAF-CRS-10PC	1	-	400 100 125	197,27	B

ComfoAir ventilation units















Product	Description	PU 1	PU 2	Article no.	Gross price €	Discount group
ComfoAir Q350 TR						
  Passive house certified  For unit connection options, see page 40	ComfoAir Q350 TR comfort ventilation unit 350 m ³ /h (200 Pa) airflow volume, cross-counterflow heat exchanger with automatic bypass, six integrated sensors to regulate the volume flow, comfort temperature and humidity. Can be used as right or left unit version. For wall mounting, incl. wall plate and integrated display with graphical user interface, pre-heater available as option; see accessories Dimensions: 775 x 850 x 570 (W x H x D)	1	4	471 502 110	3.600,00	CQ
	ComfoAir Q350 TR enthalpy comfort ventilation unit 350 m ³ /h (200 Pa) airflow volume, cross-counterflow enthalpy exchanger with automatic bypass, six integrated sensors to regulate the volume flow, comfort temperature and humidity. Can be used as right or left unit version. For wall mounting, incl. wall plate and integrated display with graphical user interface, pre-heater available as option; see accessories Dimensions: 775 x 850 x 570 (W x H x D)	1	4	471 502 111	4.448,70	CQ

*Energy efficiency class applies in conjunction with two sensors; see overview of energy efficiency classes.

Product	Description	PU 1	PU 2	Article no.	Gross price €	Discount group
ComfoAir Q450 TR						
  Passive house certified  For unit connection options, see page 40	ComfoAir Q450 TR comfort ventilation unit 450 m ³ /h (200 Pa) airflow volume, cross-counterflow heat exchanger with automatic bypass, six integrated sensors to regulate the volume flow, comfort temperature and humidity. Can be used as right or left unit version. For wall mounting, incl. wall plate and integrated display with graphical user interface, pre-heater available as option; see accessories Dimensions: 775 x 850 x 570 (W x H x D)	1	4	471 502 112	4.314,50	CQ
	ComfoAir Q450 TR enthalpy comfort ventilation unit 450 m ³ /h (200 Pa) airflow volume, cross-counterflow enthalpy exchanger with automatic bypass, six integrated sensors to regulate the volume flow, comfort temperature and humidity. Can be used as right or left unit version. For wall mounting, incl. wall plate and integrated display with graphical user interface, pre-heater available as option; see accessories Dimensions: 775 x 850 x 570 (W x H x D)	1	4	471 502 113	5.087,10	CQ

*Energy efficiency class applies in conjunction with two sensors; see overview of energy efficiency classes.

ComfoAir ventilation units





Product	Description	PU 1	PU 2	Article no.	Gross price €	Discount group
ComfoAir Q600 ST						
  Passive house certified  For unit connection options, see page 40	ComfoAir Q600 ST comfort ventilation unit 600 m ³ /h (200 Pa) airflow volume, cross-counterflow heat exchanger with automatic bypass, six integrated sensors to regulate the volume flow, comfort temperature and humidity. Can be used as right or left unit version. For wall mounting, incl. wall plate and integrated display with graphical user interface, pre-heater available as option; see accessories Dimensions: 725 x 850 x 570 (W x H x D)	1	4	471 502 114	4.867,70	CQ
	ComfoAir Q600 ST enthalpy comfort ventilation unit 600 m ³ /h (200 Pa) airflow volume, cross-counterflow enthalpy exchanger with automatic bypass, six integrated sensors to regulate the volume flow, comfort temperature and humidity. Can be used as right or left unit version. For wall mounting, incl. wall plate and integrated display with graphical user interface, pre-heater available as option; see accessories Dimensions: 725 x 850 x 570 (W x H x D)	1	4	471 502 115	5.599,10	CQ
Accessories for ComfoAir Q350/450/600						
          	ComfoSense C55 control panel for ComfoAir Q350/450/600, suitable for installing in Jung, Gira and Busch-Jaeger switch ranges, including 2 covers in RAL 9016 and 2 covers in RAL 9001 CU-CFSC55	1	-	655 010 225	293,30	C
	ComfoSense C67 control panel for ComfoAir Q350/450/600 incl. cover frame, cover and surface-mounted housing in RAL 9016 CFS-CNT67-MAC	1	-	655 010 235	329,40	C
	ComfoSwitch C55 control panel for ComfoAir Q350/450/600, suitable for installing in Jung, Gira and Busch-Jaeger switch ranges, including 2 covers in RAL 9016 and 2 covers in RAL 9001 SW-CNT55	1	-	655 010 245	148,20	C
	ComfoSwitch C67 control panel for ComfoAir Q350/450/600 incl. cover frame, cover and surface-mounted housing in RAL 9016 SW-CNT67-MAC	1	-	655 010 255	157,90	C
	Remote-controlled control panel as an additional handset for the ComfoSense C control panel CU-RF-Z1	1	-	655 000 755	141,00	C
	CO ₂ -Sensor C55, 55 mm for In-wall installation, suitable with most cover frames (not included), direct connection via ComfoNet SNS-CO2-55C	1	-	655 000 885	227,54	C
	CO ₂ -Sensor C67, 67 mm for In-wall installation, cover frame in scope of delivery, direct connection via ComfoNet SNS-CO2-67C	1	-	655 000 880	227,54	C
	CO ₂ -Sensor C67, 67 mm for On-wall installation, on-wall socket and cover frame in scope of delivery, direct connection via ComfoNet SNS-CO2-67C-MTB	1	-	655 000 875	227,54	C
	CO ₂ -Sensor V55, 55 mm for In-wall installation, suitable with most cover frames (not included), 0-10V connection, Option Box required SNS-CO2-V55	1	-	655 000 845	180,58	C
	CO ₂ -Sensor V67, 67 mm for In-wall installation, cover frame in scope of delivery, 0-10V connection, Option Box required CO2-SENSOR-0-10V-67	1	-	655 000 850	180,58	C
CO ₂ -Sensor V67, 67 mm for On-wall installation, on-wall socket and cover frame in scope of delivery, 0-10V connection, Option Box required CO2-SENSOR-0-10V-67-ON-WALL	1	-	655 000 855	180,58	C	

* Energy efficiency class applies in conjunction with two sensors; see overview of energy efficiency classes.

ComfoAir ventilation units



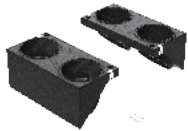



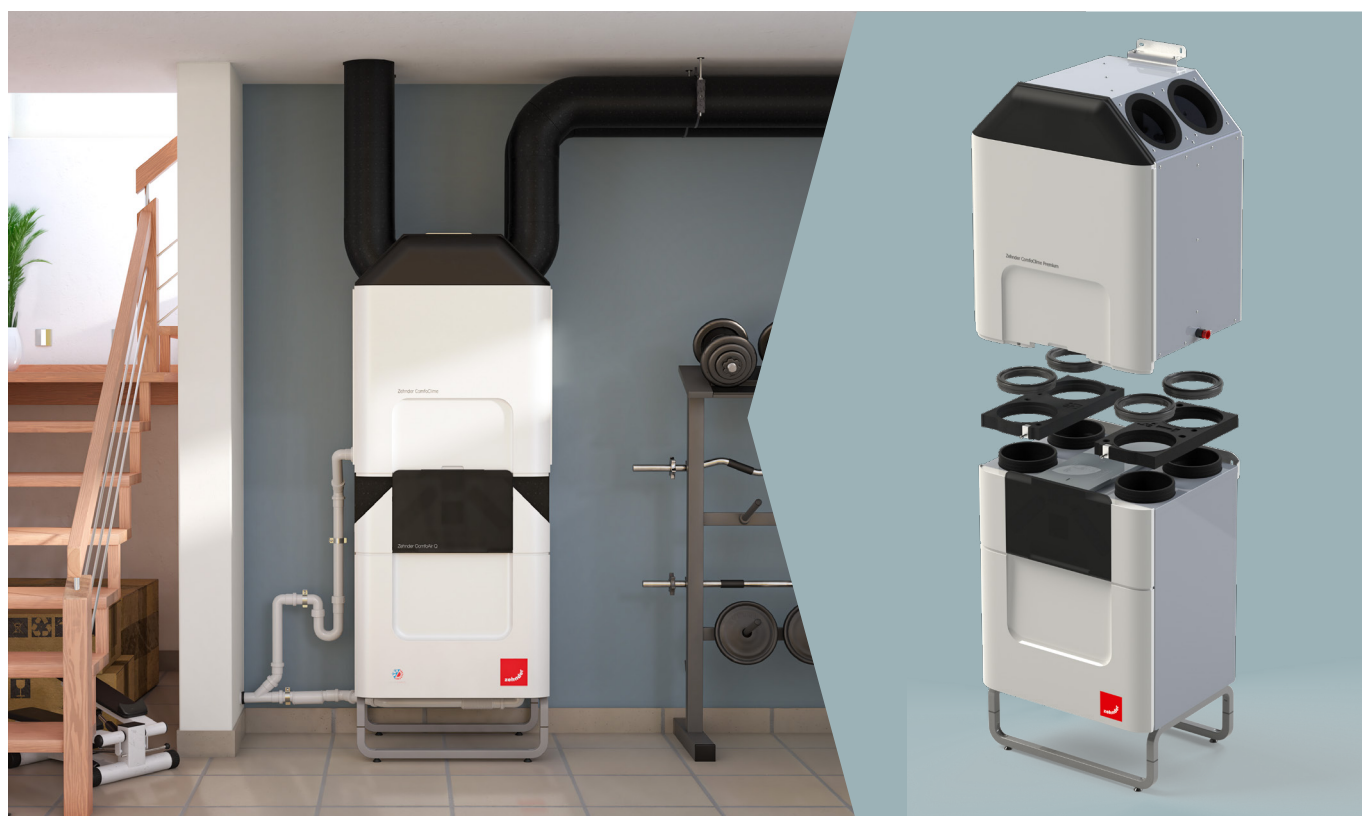

Product	Description	PU 1	PU 2	Article no.	Gross price €	Discount group
Accessories for ComfoAir Q350/450/600						
	Option Box ComfoAir Q350/450/600 for additional connection options for CO ₂ and humidity sensors as well as ComfoFond-L Q. ComfoFond-L Q only: When combined with ComfoFond-L Q, connection cable 400 300 311 needs to be ordered separately. OPB-CAQ-LIGHT VERSION-V2	1	-	471 502 143	223,00	C
	Connection cable for use of OptionBox combined with ComfoFond-L Q, lenght 2,5 m PSP-CAB-OPB-230V-10A-PCK	1	-	400 300 311	36,50	C
	ComfoConnect LAN C interface for control via app and web portal (the app is called "ComfoControl" and can be downloaded from the AppStore) GWY-LAN-CNT	1	-	655 011 100	312,50	C
	ComfoConnect KNX C interface for KNX connection options GWY-KNX-CNT	1	-	655 011 120	432,80	C
	ComfoAir Q350/450/600 pre-heater to increase the outdoor air temperature in winter (heat exchanger frost protection) PRH-CAQ-PCK	1	-	400 502 007	429,90	C
	ComfoAir Q350/450/600 mounting base Height = 255 mm FRA-CAQ	1	-	471 502 008	194,40	C
	Dry siphon 5/4" for ComfoAir Q350/450/600 SIP-5/4"-CA350/550-CF-L	1	20	990 201 330	64,00	C
	Filter set for ComfoAir Q350/450/600, ISO Coarse ≥ 65 % (G4) 2 pieces FIL-CAQ-CRS-2PC	1	-	400 502 012	43,79	B
	Filter set for ComfoAir Q350/450/600, ISO Coarse ≥ 65 % / ISO ePM1 ≥ 65 % (G4 / F7), 2 pieces FIL-CAQ-ePM1/CRS	1	-	400 502 013	46,10	B
	Filter set for ComfoAir Q350/450/600, ISO Coarse ≥ 65 % / Active carbon ePM10, 2 pieces FIL-CAQ-1PC-AC-EPM10-1PC-CRS-PCK	1	-	400 100 097	53,02	B
	Filter set for ComfoAir Q350/450/600, ISO Coarse ≥ 65 % (G4) 10 pieces FIL-CAQ-CRS-10PC	1	-	400 502 014	197,04	B
	Filter set for ComfoAir Q350/450/600, ISO ePM1 ≥ 65 % (F7) 10 pieces FIL-CAQ-ePM1-10PC	1	-	400 502 015	217,81	B

ComfoClime

Product	Description	PU 1	PU 2	Article no.	Gross price €	Discount group
	ComfoClime 24 Air-to-Air heat pump, cooling / heating unit. Suitable for air flows from 200 - 400 m ³ /h. Combinable with ComfoAir Q 350 and ComfoAir Q 450 Dimensions: 721 x 850 x 575 (W x H x D) ComfoClime 24	1	-	471 420 010	4.225,15	B
	ComfoClime 36 Air-to-Air heat pump, cooling / heating unit. Suitable for air flows from 300 - 600 m ³ /h. Combinable with ComfoAir Q 450 and ComfoAir Q 600 Dimensions: 721 x 850 x 575 (W x H x D) ComfoClime 36	1	-	471 429 207	4.536,64	B
	ComfoClime Connector for connection of ComfoAir Q 350 & 450 (TR) to ComfoClime CON-CAQ-TR-CC	1	-	990 328 763	122,42	C
	ComfoClime Connector for connection of ComfoAir Q 600 (ST) to ComfoClime CON-CAQ-ST-DN180-CC	1	-	990 328 768	122,42	C



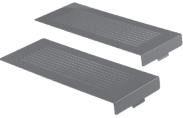







Climos ventilation unit

Product	Description	PU 1	PU 2	Article no.	Gross price €	Discount group
Climos 200						
 	Climos 200 enthalpy comfort ventilation unit 200 m ³ /h (100 Pa) airflow volume, cross-counterflow enthalpy exchanger, EC fans with constant volume flow, without condensate connection, for installation suspended from ceiling or wall, or installation in roof pitch, without control panel Dimensions: 594 x 1019 x 250 (W x L x H)			 *		
	Climos 200 L enthalpy with left supply connector (type B) CLI200-ERV-BAS-L Climos 200 R enthalpy with right supply connector (type A) CLI200-ERV-BAS-R	1	4	527 003 250	3.252,69	E
 Passive house certified 	Climos 200 V enthalpy comfort ventilation unit 200 m ³ /h (100 Pa) airflow volume, cross-counterflow enthalpy exchanger, EC fans with constant volume flow, without condensate connection, with pre-heater, for installation suspended from ceiling or wall, or installation in roof pitch, without control panel Dimensions: 594 x 1019 x 250 (W x L x H)			 *		
	Climos 200 VL enthalpy with left supply connector (type B) CLI200-ERV-COF-PRH-L Climos 200 VR enthalpy with right supply connector (type A) CLI200-ERV-COF-PRH-R	1	4	527 003 270	3.742,04	E
		1	4	527 003 260	3.742,04	E
For unit connection options, see page 40						
Climos 200 accessories						
	TFT RD control panel with colour touch panel for Climos, Focus, Novus For up to 3 ventilation units Colour: Stainless steel (housing) CU-TSS-RDS-PCK	1	20	521 014 140	538,80	C
	LED RD control panel with membrane keyboard for Climos, Focus, Novus, including cover frame Colour: RAL 9010 CU-LED-RDS-PCK	1	20	521 014 130	279,20	C
	Set designer filter cover 2 pieces Colour: RAL 3020 ACC-COV-FIL-CLI200-3020-PCK	1	15	528 007 870	113,60	C
	Filter set for Climos 200, ISO Coarse ≥ 75 % / ISO ePM1 60 % (M5 / F7) 2 pieces FIL-CLI200-CRS/M5-ePM1/F7-2PC-PCK	1	-	527 004 280	48,46	B
	Access panel for dry wall installation suitable for Climos 200 COV-SRV-L1300-W700-CLI200	1	15	528 007 930	286,20	B

* Energy efficiency class applies in conjunction with one sensor; see overview of energy efficiency classes.

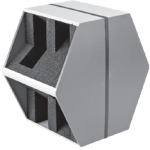
Focus ventilation unit

Product	Description	PU 1	PU 2	Article no.	Gross price €	Discount group
Focus 200						
   Passive house certified For unit connection options, see page 40	Focus 200 comfort ventilation unit 200 m ³ /h (150 Pa) airflow volume, cross-counterflow heat exchanger, EC fans with constant volume flow, for installation on wall, incl. mounting rail, without control panel Dimensions: 752 x 565 x 362 mm (W x H x D)					
	Focus 200 L with left supply connector FCS200-L	1	6	527 002 060	2.854,20	E
	Focus 200 R with right supply connector FCS200-R	1	6	527 002 070	2.854,20	E
	Focus 200 enthalpy comfort ventilation unit 200 m ³ /h (150 Pa) airflow volume, cross-counterflow enthalpy exchanger, EC fans with constant volume flow, for installation on wall, incl. mounting rail, without control panel Dimensions: 752 x 565 x 362 mm (W x H x D)					
	Focus 200 L enthalpy with left supply connector FCS200-ERV-L	1	6	527 002 080	3.282,60	E
	Focus 200 R enthalpy with right supply connector FCS200-ERV-R	1	6	527 002 090	3.282,60	E
Focus 200 accessories						
	TFT RD control panel with colour touch panel for Climos, Focus, Novus For up to 3 ventilation units Colour: Stainless steel (housing) CU-TSS-RDS-PCK	1	-	521 014 140	538,80	C
	LED RD control panel with membrane keyboard for Climos, Focus, Novus, including cover frame Colour: RAL 9010 CU-LED-RDS-PCK	1	-	521 014 130	279,20	C
	Focus summer box module for replacing the heat exchanger for summer ventilation SBX-FCS200	1	30	527 002 940	142,40	B
	Mounting base height-adjustable = 280 mm – 320 mm FRA-FCS200-GAL	1	10	527 002 280	142,40	C
	Dry siphon 5/4" for Focus and Novus SIP-5/4"-CA350/550-CF-L	1	20	990 201 330	64,00	C
	Filter set for Focus 200, ISO Coarse ≥ 70 % / ISO ePM1 ≥ 60 % (G4 / F7) 2 pieces FIL-FCS-CCP-CRS/G4-ePM1/F7-2PC-PCK	1	-	527 003 430	47,60	B
	Filter set for Focus 200, ISO Coarse ≥ 60 % 10 pieces FIL-FCS-CCP-ePM1/F7-10PC-PCK	1	-	527 009 750	220,04	B

* Energy efficiency class applies in conjunction with two sensors; see overview of energy efficiency classes.

** Energy efficiency class applies in conjunction with a manual control; see overview of energy efficiency classes.

Enthalpy exchanger

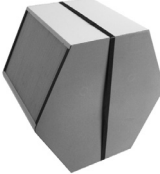
Product	Description	PU 1	PU 2	Article no.	Gross price €	Discount group
Enthalpy exchanger						
	Enthalpy exchanger for humidity and heat recovery for ComfoAir Q350/450/600 HEX-ERV-370-H500-S-006512-PCK	1	4	400 502 010	1.359,30	B
	for ComfoAir G90/G91/350 HEX-ERV-366-H378-S-002071-PCK	1	-	400 400 013	1.256,60	B
	for ComfoAir 160 HEX-MOD-ERV-G90/CA160	1	-	400 400 037	1.871,10	B
	for ComfoAir 180 HEX-ERV-366-H200-B-003267-PCK	1	-	400 400 039	1.760,40	B
	for ComfoAir 200 HEX-ERV-366-H200-B-003267-PCK	1	-	400 400 039	1.871,10	B
	for ComfoAir 200 HEX-ERV-450-H310-R-002906-PCK	1	-	400 400 017	1.511,30	B
	for ComfoAir 500/550 and Novus 300/450 HEX-ERV-366_H500-S-000254-PCK	1	-	400 400 014	690,00	B
	for Focus 200 HEX-ERV-366-H265-S-003097-PCK	1	-	527 007 480		B

Defroster heater, demand control

Product	Description	PU 1	PU 2	Article no.	Gross price €	Discount group
Defroster heater						
	Iso defroster heater DN 160 with 2000 W PTC heating element including ISO Coarse filter $\geq 70\%$ (G3), without control unit PRH-EPP-DN160-2kW-CRS/G3	1	24	527 001 360	446,30	C
	Iso defroster heater DN 125 with 700 W PTC heating element including ISO Coarse filter $\geq 50\%$ (G3), without control unit PRH-EPP-DN125-700W-CRS/G3	1	40	527 003 450	301,20	C
	Universal thermostat control unit for iso defroster heater including 10 kOhm NTC sensor, cable length 3 m for units with LED control panel UNI-THE-SET-PCK	1	8	521 008 820	388,10	C
	BUS thermostat RD control unit for iso defroster heater including CAT5 cable, 10 kOhm NTC sensor, cable length 3 m for units with TFT control panel BUS-THE-RDS-SET-PCK	1	8	527 004 530	284,80	C
Demand control						
	CO ₂ -Sensor V55, 55 mm for In-wall installation, suitable with most cover frames (not included) SNS-CO2-V55	1	-	655 000 845	180,58	C
	CO ₂ -Sensor V67, 67 mm for In-wall installation, cover frame in scope of delivery CO2-SENSOR-0-10V-67	1	-	655 000 850	180,58	C
	CO ₂ -Sensor V67, 67 mm for On-wall installation, on-wall socket and cover frame in scope of delivery CO2-SENSOR-0-10V-67-ON-WALL	1	-	655 000 855	180,58	C
	CO ₂ sensor, on-wall 0 – 10 V control output SNS-CO2-12DC-0/10V-PCK	1	-	528 007 250	612,40	C
	Humidity sensor, on-wall 0 – 10 V control output SNS-RH-SFM	1	-	659 000 330	581,80	C

Connectivity & Controls

Ventilation unit	Type of connection / Required accessories	Controller
ComfoAir 160	0-10 V direct	CO ₂ Sensor V
ComfoAir 180		
ComfoAir 200		
ComfoAir Q	0-10 V with Option Box	CO ₂ Sensor V
	ComfoConnect LAN C + ComfoNet	ComfoControl App
ComfoAir Flex	ComfoNet	CO ₂ Sensor C
	Peer-to-peer (WiFi)	ComfoControl App



RapidLock
Connection

Click!



Zehnder ComfoFresh air distribution system 42 – 87

Overview of connection components for ventilation units	42
Connection accessories for ventilation units	44
Overview of example combinations with ComfoWell	49
ComfoWell	52
Air distribution manifolds	57
ComfoCube Flex	58
Overview of example combinations with ComfoCube Flex	60
Silencers	63
ComfoTube Therm insulated air distribution system	64
ComfoWell Therm	66
InFloor air distribution	67
OnFloor air distribution	74
Overview of InFloor and OnFloor designer grilles	79
InFloor designer grilles	81
OnFloor designer grilles	84
InFloor and OnFloor valves	85



Zehnder RapidLock®

Quick. Easy. Secure: New connection technology for Zehnder air distribution systems



Advantages:

- Strong, secure and air-tight connection combined with easy application
- Compact design for space saving installation
- Flexible mounting in every building situation
- Easy access for cleaning and maintenance



Function:

- Quick and secure connection of ventilation tubes ComfoTube 75 and 90 through easy insertion even when turned 90°, thanks to the pre-installed clips
- Strong connection thanks to smart construction - RapidLock® prevents unintended loosening of the connection, but allows easy separation for maintenance and cleaning
- Air-tight connection avoids unwanted leakage

















The future of air distribution installation
Discover Zehnder RapidLock®:







Products with RapidLock® technology:

- ComfoWell mounting plates (p. 51)
- Module manifold boxes (p. 55)
- Grille housing CLD/P & selected components of ComfoTube 70 and 90 air distribution systems (p. 57 ff.)

Overview of connection components for ventilation units				
Ventilation units Connection line	ComfoAir 160 	ComfoAir 200 	ComfoAir Q350 TR 	ComfoAir Q450 TR 
ComfoPipe Compact flexible duct 				
Aluminium lined flexible duct 125 	Direct	Connection nipple DN 125 990 326 330		
Aluminium lined flexible duct 160 			Connection nipple DN 160 990 326 331	Connection nipple DN 160 990 326 331
Aluminium lined flexible duct 180 				
Aluminium lined flexible duct 200 				
ComfoPipe Compact 125 	ComfoPipe Compact sleeve 990 328 692	Connection nipple DN 125 990 326 330		
ComfoPipe Compact 160 			ComfoPipe Compact sleeve 990 328 695	ComfoPipe Compact sleeve 990 328 695
ComfoPipe Compact 200 				
ComfoPipe Plus 160 			ComfoPipe Plus 160 ComfoAir Q connecting bend 990 328 704	ComfoPipe Plus 160 ComfoAir Q connecting bend 990 328 704
ComfoPipe Plus 200 				

Overview of connection components for ventilation units

ComfoAir Q600 ST	Climos 200	Focus 200	ComfoClima 24	ComfoClima 36
				
			Direct	Direct
	Connection nipple DN 125 990 326 330	Connection nipple DN 125 990 326 330		
Connection nipple DN 180 990 326 332				
Reducer DN 180/200 990 326 352				
	Connection nipple DN 125 990 326 330	Connection nipple DN 125 990 326 330		
			ComfoPipe Compact DN 160 bend 45° 990 328 694	
Direct				ComfoPipe Compact DN 200 bend 45° 990 328 697
ComfoPipe Plus 200 Adapter 990 328 723				





Connection accessories for ventilation units

Product	Description	PU 1	PU 2	Article no.	Gross price €	Discount group
ComfoPipe Plus						
	ComfoPipe Plus tube, complies with the insulation requirements of DIN 1946-6 in the thermal casing up to 60 mm insulation thickness, material EPP and integral plug-in connector					
	DN 160 L = 1000 mm D = 246 / 160 mm TUB-CPP-DN160-L1M DN 200 L = 1000 mm, D = 286 / 200 mm TUB-CPP-DN200-L1M	1	14	990 328 700	68,40	C
		1	11	990 328 720	92,00	C
	ComfoPipe Plus bend, complies with the insulation requirements of DIN 1946-6 in the thermal casing up to 60 mm insulation thickness, material EPP and integral plug-in connector					
	DN 160 bend 45°, D = 246 / 160 mm BEN-CPP-DN160X45 DN 200 bend 45°, D = 286 / 200 mm BEN-CPP-DN200X45	1	64	990 328 701	29,80	C
		1	48	990 328 721	48,50	C
	ComfoPipe Plus sleeve, complies with the insulation requirements of DIN 1946-6 in the thermal casing up to 60 mm insulation thickness, material EPP and integral plug-in connector					
	DN 160 D = 277 / 246 mm CON-CPP-DN160-M DN 200 D = 326 / 286 mm CON-CPP-DN200-M	1	144	990 328 702	24,60	C
		1	104	990 328 722	31,30	C
	ComfoPipe Plus connecting bend 160 for ComfoAir Q350/450 TR ventilation unit connector, complies with the insulation requirements of DIN 1946-6 in the thermal casing up to 60 mm insulation thickness, material EPP and integral plug-in connector 2 piece	1	20	990 328 704	60,80	C
	ComfoPipe Plus 200 adapter, complies with the insulation requirements of DIN 1946-6 in the thermal casing up to 60 mm insulation thickness, for mounting ComfoPipe Plus to ComfoAir Q 600, material EPP CON-CA550/CPP-DN200	1	30	990 328 723	70,10	C
ComfoPipe Plus connector set for ComfoFond-L Q						
	ComfoPipe Plus 160 connector set for ComfoFond-L Q TR to ComfoAir Q350/450 TR consisting of junction, adjustable bracket, sleeve and ComfoPipe Plus adapter to ComfoFond-L Q TR CON-CAQ350/450/CF-L-SLN-CPP-DN160-SET	1	-	990 328 750	76,10	C
	ComfoPipe Plus 200 connector set for ComfoFond-L Q ST to ComfoAir Q600 ST consisting of junction and ComfoPipe Plus adapter to ComfoFond-L Q ST CON-CAQ600/CF-L-SLN-CPP-DN200-SET	1	-	990 328 751	85,40	C





Connection accessories for ventilation units

Product	Description	PU 1	PU 2	Article no.	Gross price €	Discount group
ComfoPipe Compact						
	ComfoPipe Compact tube material EPP					
	125 L = 1000 mm, D = 155 / 125 mm TUB-CPCP-DN125-L1m	1	6	990 328 690	40,38	C
	160 L = 1000 mm, D = 190 / 160 mm TUB-CPCP-DN160-L1m	1	4	990 328 693	38,65	C
	200 L = 1000 mm, D = 230 / 200 mm TUB-CPCP-DN200-L1m	1	3	990 328 696	87,50	C
	ComfoPipe Compact bend material EPP					
	125 bend 45° tube, D = 155 / 125 mm BEN-CPCP-DN125x45	1	28	990 328 691	17,54	C
	160 bend 45° tube, D = 190 / 160 mm BEN-CPCP-DN160x45	1	18	990 328 694	14,77	C
	200 bend 45° tube, D = 230 / 200 mm BEN-CPCP-DN200x45	1	14	990 328 697	32,70	C
	ComfoPipe Compact sleeve					
	125 D = 179 / 155 mm CON-CPCP-DN125-M	1	40	990 328 692	16,27	C
	160 D = 214 / 190 mm CON-CPCP-DN160-M	1	48	990 328 695	15,92	C
	200 D = 254 / 230 mm CON-CPCP-DN200-M	1	40	990 328 698	23,20	C
	ComfoPipe Compact double socket					
	125 D = 185 / 155 mm CON-CPCP-DN125-M/M	1	40	990 328 760	15,81	C
	160 D = 220 / 190 mm CON-CPCP-DN160-M/M	1	48	990 328 761	15,81	C
	200 D = 260 / 230 mm CON-CPCP-DN200-M/M	1	40	990 328 762	24,80	C
	ComfoPipe junction 180 mm to 160 mm, material galvanised steel, with seal TRA-SEL-CP-DN180/160	1	20	990 328 664	30,70	C
	ComfoPipe Compact junction 200 mm to 180 mm, junction to connect ComfoFond-L Q ST to ComfoPipe Compact DN 200 TRA-CPP-DN200/180	1	20	990 326 341	35,00	C
	Reducer, with seal					
	DN 160/125 TRA-SEL-DN160/125-N	1	-	990 326 336	22,20	C
	DN 160/150 TRA-SEL-DN160/150-N	1	60	990 326 346	24,50	C
	DN 180/160 TRA-SEL-DN180/160-N	1	50	990 326 337	25,10	C
	DN 200/180 TRA-SEL-DN180/200-N	1	30	990 326 352	29,80	C

Connection accessories for ventilation units

Product	Description	PU 1	PU 2	Article no.	Gross price €	Discount group
Connection accessories						
	Y piece 45° designation DN entry/straight/branch, with seal					
	DN 125/125/125 YPI-SEL-DN125/125/125x45	1	50	990 326 300	59,70	C
	DN 160/160/160 YPI-SEL-DN160/160/160x45	1	20	990 326 301	87,40	C
	DN 200/200/200 YPI-SEL-DN200/200/200x45	1	8	990 326 316	160,00	C
	Connection nipple for connecting aluminium lined flexible duct/ComfoPipe to roof housing or unit connector, with seal					
	DN 125 CON-SEL-DN125-N	1	500	990 326 330	10,40	C
	DN 160 CON-SEL-DN160-N	1	250	990 326 331	10,90	C
	DN 200 CON-SEL-DN200-N	1	40	990 326 339	14,10	C
	Straight connector					
	DN 125 CON-DN125-M	1	-	990 326 333	10,40	C
	DN 160 CON-DN160-M	1	-	990 326 334	10,90	C
	DN 200 CON-DN200-M	1	-	990 326 340	14,10	C
	Reducer, with seal					
	DN 160/125 TRA-SEL-DN160/125-N	1	-	990 326 336	22,20	C
	DN 160/150 TRA-SEL-DN160/150-N	1	60	990 326 346	24,50	C
	DN 200/180 TRA-SEL-DN180/200-N	1	30	990 326 352	29,80	C

Connection accessories for ventilation units

Product	Description	PU 1	PU 2	Article no.	Gross price €	Discount group
Connection accessories						
	ComfoPipe Compact flexible element for connecting ComfoClime unit with ComfoPipe Compact, black, PU: 1 m					
	DN 160 TUB-FLEX-CON-CPCP-DN160-1m	1	-	990 328 765	101,60	C
	DN 200 TUB-FLEX-CON-CPCP-DN200-1m	1	-	990 328 766	122,10	C
	Aluminium lined flexible duct for connecting ventilation unit to manifold box PU: 10 m					
	DN 125 TUB-DN125-L10m	1	-	990 319 012	114,40	C
	DN 160 TUB-DN160-L10m	1	-	990 319 016	146,50	C
	Aluminium lined flexible duct insulated for exhaust and outdoor air, PU: 6 m					
	DN 125 TUB-ISO-DN125-L6m	1	-	990 319 112	167,00	C
	DN 160 TUB-ISO-DN160-L6m	1	-	990 319 271	200,00	C
	DN 200 TUB-ISO-DN200-L6m	1	-	990 319 273	247,90	C
	Tube clamp 9 mm wide, diameter 60 – 215 mm, for securing aluminium lined flexible duct, 10 pieces MAC-HOC-W9-DN125/200-10PC	1	100	990 319 321	59,70	C
	ComfoFix Link Tube holder for ComfoPipe DN125, 160 & 200 4pcs PU1 - 1 PU2 - 1 MAC-CPCP-CPP-HLD-4PC	1	32	990 327 300	37,70	C

How ComfoFix Link can be applied.

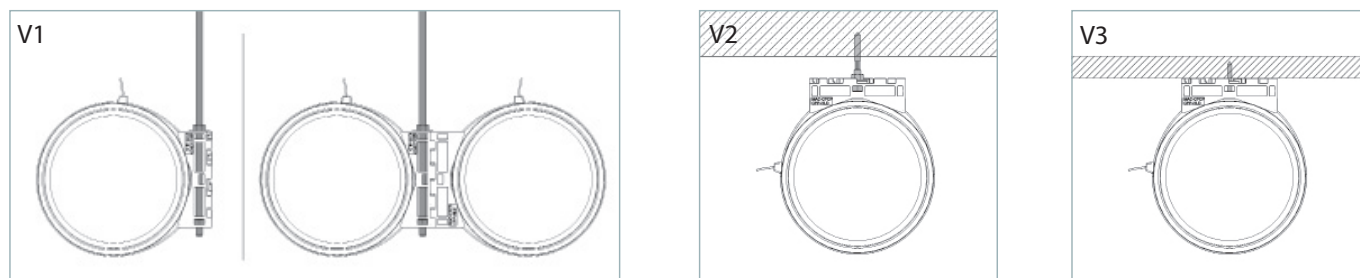

ComfoWell

Zehnder ComfoWell, the modular system for silencers, filters and distribution manifolds.

All components within a width can be directly connected to and combined with one another.

Components can be used as a duct installation, in combination (e.g. silencer + silencer or silencer + manifold box) or directly on the ventilation unit.

For example combinations, see page 47 onwards.

The system consists of five widths:

220 series for 4 connectors and max. 160 m³/h at a normal ventilation level for ComfoTube 75 or 90





320 series for 6 connectors and max. 240 m³/h at a normal ventilation level for ComfoTube 75 or 90

420 series for 8 connectors and max. 320 m³/h at a normal ventilation level for ComfoTube 75 or 90

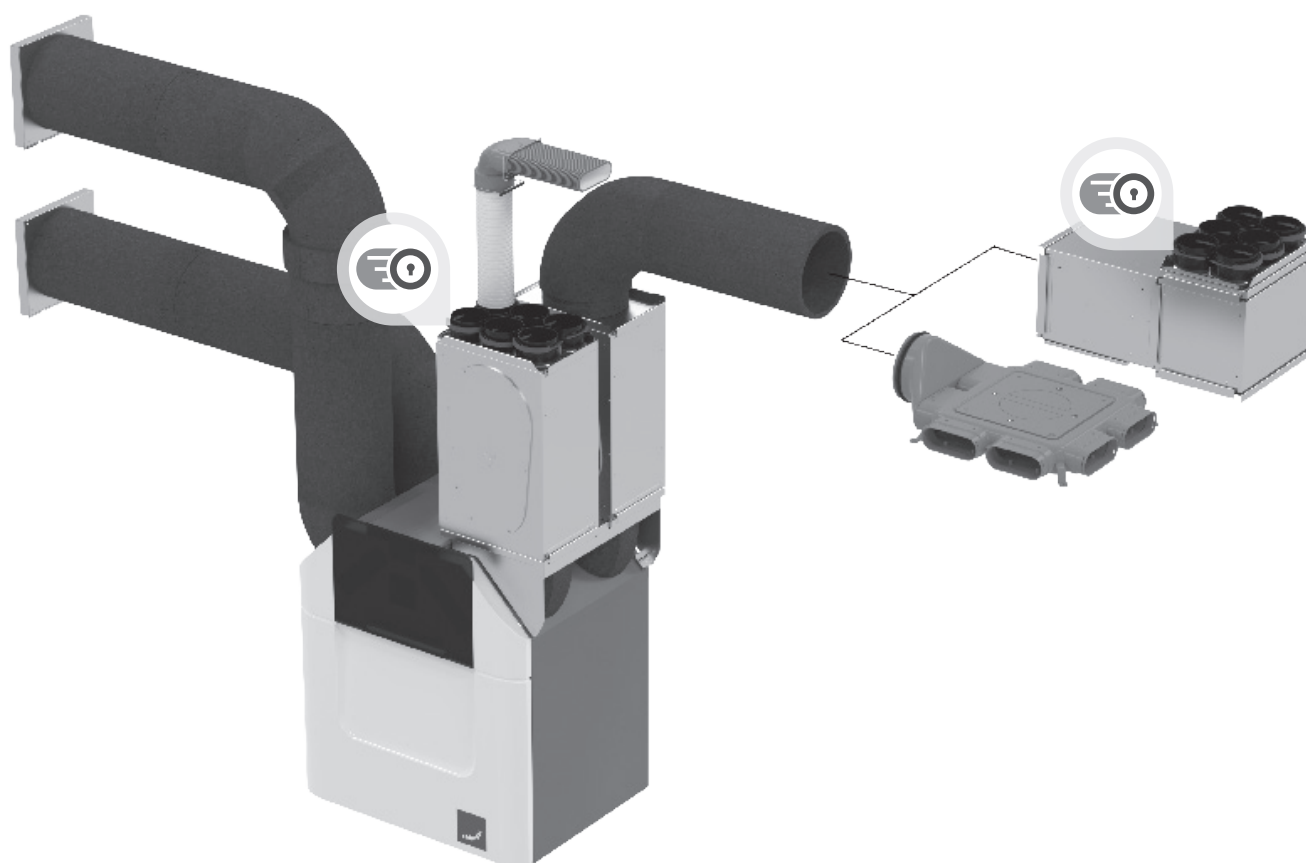
520 series for 10 connectors and max. 400 m³/h at a normal ventilation level for ComfoTube 75 or 90



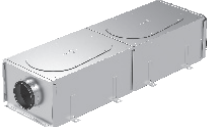

625 series for 12 connectors and max. 480 m³/h at a normal ventilation level for ComfoTube 75 or 90





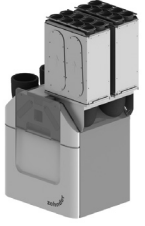



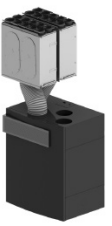

Overview of example combinations with ComfoWell					
Combination options	Silencer DN 125	Manifold DN 125 with 6 x ComfoTube 75	Filter housing DN 160, filter F7 or with active carbon filter	Silencer / manifold combination with 6 x ComfoTube 75 connections, DN 125	Silencer / manifold combination with 6 x ComfoTube 75 connections, DN 125
Individual components					
Silencer	1 x Silencer CW-S 320 990 323 501			1 x Silencer CW-S 320 990 323 501	2 x Silencer CW-S 320 990 323 501
Manifold box		1 x Manifold box CW-D 320 990 323 531		1 x Manifold box CW-D 320 990 323 531	
Mounting plate		1 x Mounting plate CW-M 320-6 x 75/P 990 323 612		1 x Mounting plate CW-M 320-6 x 75/P 990 323 612	1 x Mounting plate CW-M 320-6 x 75/P 990 323 612
Filter housing			1 x Filter housing CW-F 320 990 323 551		
Fine dust filter			1 x Fine dust filter CW 320-PM1-75% 990 323 603		
Active carbon filter			1 x Active carbon filter CW-FC 320 990 323 605		
End plate	2 x End plate CW-P 320 DN 125 centric 990 323 511	1 x End plate CW-P 320 DN 125 centric 990 323 511	2 x End plate CW-P 320 DN 160 centric 990 323 512	1 x End plate CW-P 320 DN 125 centric 990 323 511	1 x End plate CW-P 320 DN 125 990 323 511

Overview of example combinations with ComfoWell				
Combination options	Silencer / manifold combination to ComfoAir 160 with 2 x 4 ComfoTube 75 connectors	Silencer / manifold combination to ComfoAir 200 with 2 x 6 ComfoTube 75 connectors	Silencer / manifold combination for ComfoAir Q350 TR with 2 x 8 ComfoTube 75 connectors	Silencer / manifold combination for ComfoAir Q350 TR with 2 x 12 ComfoTube 75 connectors
Individual components				
Silencer 	2 x Silencer CW-S 220 990 323 500	2 x Silencer CW-S 320 990 323 501	2 x Silencer CW-S 420 990 323 504	2 x Silencer CW-S 625 990 323 505
Mounting plate 	2 x Mounting plate CW-M 220-4 x 75/P 990 323 610	2 x Mounting plate CW-M 320-6 x 75/P 990 323 612	2 x Mounting plate CW-M 420-8 x 75/P 990 323 621	2 x Mounting plate CW-M 625-12 x 75/P 990 323 631
Mounting set 	1 x Mounting set CW-K220 CA 160 990 323 569	1 x Mounting set CW-K320 CA 200 990 323 517	1 x Mounting set CW-K 420 ComfoAir Q350/450 TR 990 323 640	1 x Mounting set CW-K 625 ComfoAir Q350/450 TR 990 323 643
End plate 				
Aluminium lined flexible duct 				
Connection nipple 				









Overview of example combinations with ComfoWell

Silencer / manifold combination for ComfoAir Q450 TR with 2 x 8 ComfoTube 90 connectors	Silencer / manifold combination for ComfoAir Q600 ST with 2 x 12 ComfoTube 90 connectors	Silencer / manifold combination for Focus 200 with 2 x 4 ComfoTube 75 connectors	Silencer / manifold combination for Climos 200 with 2 x 6 ComfoTube 75 connectors	Silencer / manifold combination for Novus 300 with 2 x 10 ComfoTube 75 connectors
				
2 x Silencer CW-S 420 990 323 504	2 x Silencer CW-S 625 990 323 505	2 x Silencer CW-S 220 990 323 500	2 x Silencer CW-S 320 990 323 501	2 x Silencer CW-S 520 990 323 502
2 x Mounting plate CW-M 420-8 x 90/P 990 323 622	2 x Mounting plate CW-M 625-12 x 90/P 990 323 632	2 x Mounting plate CW-M 220-4 x 75/P 990 323 610	2 x Mounting plate CW-M 320-6 x 75/P 990 323 612	2 x Mounting plate CW-M 520-10 x 75/P 990 323 614
1 x Mounting set CW-K 420 ComfoAir Q350/450 TR 990 323 640	1 x Mounting set CW-K 625 ComfoAir Q600 ST 990 323 642			
		2 x End plate CW-P 220-DN125 990 323 510	2 x End plate CW-P 320-DN125 990 323 511	2 x End plate CW-P 520-DN160 990 323 564
		Aluminium lined flexible duct DN125 990 319 012		Aluminium lined flexible duct DN160 990 319 016
		2 x Connection nipple DN 125 990 326 330		2 x Connection nipple DN 160 990 326 331



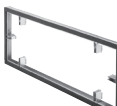

ComfoWell

Product	Description	PU 1	PU 2	Article no.	Gross price €	Discount group
	<p>Silencer without end plates, with highly efficient sound absorption material including clamping rails and fastening material</p> <p>Silencer CW-S 220 dimensions: 500 x 220 x 230 (L x W x D) SIL-CW220</p>	1	30	990 323 500	186,20	C
	<p>Silencer CW-S 320 dimensions: 500 x 320 x 230 (L x W x D) SIL-CW320</p>	1	20	990 323 501	208,30	C
	<p>Silencer CW-S 420 dimensions: 500 x 420 x 230 (L x W x D) SIL-CW420</p>	1	-	990 323 504	243,70	C
	<p>Silencer CW-S 520 dimensions: 500 x 520 x 230 (L x W x D) SIL-CW520</p>	1	12	990 323 502	281,90	C
	<p>Silencer CW-S 625 dimensions: 500 x 625 x 230 (L x W x D) SIL-CW625</p>	1	10	990 323 505	319,00	C
	<p>Manifold box without end plates, with sound-absorbing interior lining and inspection plate, for mounting plate, including clamping rails and fastening material</p> <p>Manifold box CW-D 220 dimensions: 230 x 220 x 230 (L x W x D) DIS-CW220-DIV</p>	1	32	990 323 530	138,20	C
	<p>Manifold box CW-D 320 dimensions: 230 x 320 x 230 (L x W x D) DIS-CW320-DIV</p>	1	28	990 323 531	172,40	C
	<p>Manifold box CW-D 420 dimensions: 230 x 420 x 230 (L x W x D) DIS-CW420-DIV</p>	1	-	990 323 620	194,40	C
	<p>Manifold box CW-D 520 dimensions: 230 x 520 x 230 (L x W x D) DIS-CW520-DIV</p>	1	28	990 323 532	217,70	C
	<p>Manifold box CW-D 625 dimensions: 230 x 625 x 230 (L x W x D) DIS-CW625-DIV</p>	1	-	990 323 630	239,50	C

ComfoWell

Product	Description	PU 1	PU 2	Article no.	Gross price €	Discount group
	Mounting plate for connecting ComfoTube 75 or 90, suitable for manifold box or silencer, including clamping rails. ComfoTube connector made of plastic with increased tightness and stability.					
	Mounting plate CW-M 220-4 x 75/P dimensions: 220 x 40 x 230 (W x H x D), with Zehnder RapidLock [®] MPL-CW220-4DN75/P-RLC	1	10	990 323 610	69,60	C
	Mounting plate CW-M 220-4 x 90/P dimensions: 220 x 40 x 230 (W x H x D), with Zehnder RapidLock [®] MPL-CW220-4DN90/P-RLC	1	10	990 323 611	78,70	C
	Mounting plate CW-M 320-6 x 75/P dimensions: 320 x 40 x 230 (W x H x D), with Zehnder RapidLock [®] MPL-CW320-6DN75/P-RLC	1	10	990 323 612	88,50	C
	Mounting plate CW-M 320-6 x 90/P dimensions: 320 x 40 x 230 (W x H x D), with Zehnder RapidLock [®] MPL-CW320-6DN90/P-RLC	1	10	990 323 613	97,20	C
	Mounting plate CW-M 420-8 x 75/P dimensions: 420 x 40 x 230 (W x H x D), with Zehnder RapidLock [®] MPL-CW420-8DN75/P-RLC	1	-	990 323 621	105,80	C
	Mounting plate CW-M 420-8 x 90/P dimensions: 420 x 40 x 230 (W x H x D), with Zehnder RapidLock [®] MPL-CW420-8DN90/P-RLC	1	-	990 323 622	123,50	C
	Mounting plate CW-M 520-10 x 75/P dimensions: 520 x 40 x 230 (W x H x D), with Zehnder RapidLock [®] MPL-CW520-10DN75/P-RLC	1	10	990 323 614	123,20	C
	Mounting plate CW-M 520-10 x 90/P dimensions: 520 x 40 x 230 (W x H x D), with Zehnder RapidLock [®] MPL-CW520-10DN90/P-RLC	1	10	990 323 615	150,70	C
	Mounting plate CW-M 625-12 x 75/P dimensions: 625 x 40 x 230 (W x H x D), with Zehnder RapidLock [®] MPL-CW625-12DN75/P-RLC	1	-	990 323 631	141,10	C
	Mounting plate CW-M 625-12 x 90/P dimensions: 625 x 40 x 230 (W x H x D), with Zehnder RapidLock [®] MPL-CW625-12DN90/P-RLC	1	-	990 323 632	175,30	C
	Spacer frame for compensating unevenness when fitting to mounting plate, including securing pins					
	Spacer frame CW-DF 220 with clamping rails and sliding part dimensions: 220 x 24 x 230 (W x H x D) MAC-CW220-FRA-MF	1	10	990 323 537	61,70	C
	Spacer frame CW-DF 320 with clamping rails and sliding part dimensions: 320 x 24 x 230 (W x H x D) MAC-CW320-FRA-MF	1	10	990 323 538	65,90	C
	Spacer frame CW-DF 420 with clamping rails and sliding part dimensions: 436 x 28 x 230 (W x H x D) MAC-CW420-FRA-MF	1	-	990 323 624	67,70	C
	Spacer frame CW-DF 520 with clamping rails and sliding part dimensions: 520 x 24 x 230 (W x H x D) MAC-CW520-FRA-MF	1	10	990 323 539	69,60	C
	Spacer frame CW-DF 625 with clamping rails and sliding part dimensions: 641 x 28 x 230 (W x H x D) MAC-CW625-FRA-MF	1	-	990 323 634	72,00	C

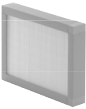

ComfoWell

Product	Description	PU 1	PU 2	Article no.	Gross price €	Discount group
     	Filter housing without filter and end plate, for accommodating one fine dust filter or active carbon filter, including clamping rails and fastening material					
	Filter housing CW-F 220 dimensions: 300 x 220 x 230 (L x W x D) FHO-CW220	1	40	990 323 550	200,00	C
	Filter housing CW-F 320 dimensions: 300 x 320 x 230 (L x W x D) FHO-CW320	1	40	990 323 551	227,30	C
	Filter housing CW-F 420 dimensions: 300 x 420 x 230 (L x W x D) FHO-CW420	1	-	990 323 554	236,90	C
	Filter housing CW-F 520 dimensions: 300 x 520 x 230 (L x W x D) FHO-CW520	1	30	990 323 552	246,40	C
	Filter housing CW-F 625 dimensions: 300 x 625 x 230 (L x W x D) FHO-CW625	1	-	990 323 555	257,50	C
	Fine dust filter CW 220-PM1-90% dimensions: 200 x 225 x 48 (L x W x D), filter ISO ePM1 ≥ 90 % (F9) FIL-CW220-PM1-90%	1	108	990 323 601	54,81	B
	Fine dust filter CW 320-PM1-90% dimensions: 300 x 225 x 48 (L x W x D), filter ISO ePM1 ≥ 90 % (F9) FIL-CW320-PM1-90%	1	72	990 323 604	59,94	B
	Fine dust filter CW 420-PM1-90% dimensions: 2 pieces, each 200 x 225 x 48 (L x W x D), filter ISO ePM1 ≥ 90 % (F9) FIL-CW420-PM1-90%	1	-	990 323 651	76,04	B
	Fine dust filter CW 520-PM1-90% dimensions: 500 x 225 x 48 (L x W x D), filter ISO ePM1 ≥ 90 % (F9) FIL-CW520-PM1-90%	1	48	990 323 607	80,13	B
Fine dust filter CW 625-PM1-90% dimensions: 2 pieces, each 300 x 225 x 48 (L x W x D), filter ISO ePM1 ≥ 90 % (F9) FIL-CW625-PM1-90%	1	-	990 323 654	92,25	B	

ComfoWell

Product	Description	PU 1	PU 2	Article no.	Gross price €	Discount group
	Active carbon filters for installing in filter housing Active carbon filter CW-FC 220 dimensions: 200 x 225 x 96 (L x W x D) FIL-CW220-AC	1	54	990 323 602	39,92	B
	Active carbon filter CW-FC 320 dimensions: 300 x 225 x 96 (L x W x D) FIL-CW320-AC	1	36	990 323 605	46,33	B
	Active carbon filter CW-FC 420 dimensions: 2 pieces, each 200 x 225 x 96 (L x W x D) FIL-CW420-AC	1	-	990 323 652	56,88	B
	Active carbon filter CW-FC 520 dimensions: 500 x 225 x 96 (L x W x D) FIL-CW520-AC	1	24	990 323 608	67,15	B
	Active carbon filter CW-FC 625 dimensions: 2 pieces, each 300 x 225 x 96 (L x W x D) FIL-CW625-AC	1	6	990 323 655	76,04	B
	Mounting set for direct fitting of ComfoWell components on the ventilation unit Mounting set CW-K 220 – CA 160 dimensions: 220 x 95 x 230 (W x H x D) EPL-CW220-CA160-MAC	1	-	990 323 569	135,40	C
	Mounting set CW-K 320 – CA 160 dimensions: 320 x 95 x 230 (W x H x D) EPL-CW320-CA160-MAC	1	-	990 323 570	161,50	C
	End plate CW-P 220 – DN 125, eccentric for connecting ComfoWell silencer / manifold combination, including clamping rail, suitable for ComfoAir 180 for direct downwards supply connector dimensions: 220 x 443 x 230 mm (L x W x H) EPL-CW220-CA180-MAC	1	10	990 323 577	52,60	C
	Mounting set CW-K 320 – CA 200 dimensions: 320 x 26 x 230 (W x H x D) EPL-CW320-CA200-MAC	1	10	990 323 517	161,50	C
	Mounting set CW-K-320 – ComfoAir Q350/450 TR EPL-CW320-CAQ350/450-SLN-MAC	1	-	990 323 644	179,40	C
	Mounting set CW-K-420 – ComfoAir Q350/450 TR EPL-CW420-CAQ350/450-SLN-MAC	1	15	990 323 640	183,60	C
	Mounting set CW-K-420 – ComfoAir Q600 ST EPL-CW420-CAQ450/600-STT-MAC	1	-	990 323 641	179,40	C
	Mounting set CW-K-520 – ComfoAir Q350/450 TR EPL-CW520-CAQ350/450-SLN-MAC	1	15	990 323 645	189,00	C
	Mounting set CW-K-520 – ComfoAir Q600 ST EPL-CW520-CAQ450/600-STT-MAC	1	15	990 323 646	183,60	C
	Mounting set CW-K-625 – ComfoAir Q350/450 TR EPL-CW625-CAQ350/450-STT-MAC	1	15	990 323 643	194,40	C
	Mounting set CW-K-625 – ComfoAir Q600 ST EPL-CW625-CAQ450/600-STT-MAC	1	15	990 323 642	189,00	C
	Mounting set CW-K 220 – ComfoAir Flex 250/350 EPL-CW220-CAF250/350-EXC-MAC	1	-	990 323 710	104,40	C
	Mounting set CW-K-320 – ComfoAir Flex 250/350 EPL-CW320-CAF250/350-EXC-MAC	1	-	990 323 711	153,00	C
	Mounting set CW-K-420 – ComfoAir Flex 250/350 EPL-CW420-CAF250/350-EXC-MAC	1	-	990 323 712	173,70	C

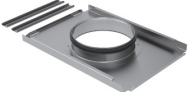
ComfoWell

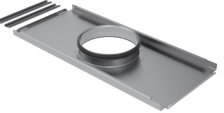
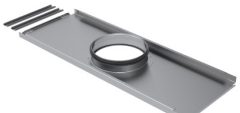
Product	Description	PU 1	PU 2	Article no.	Gross price €	Discount group
	End plate with connector, centric, including clamping rails End plate CW-P 220 – DN 125 dimensions: 220 x 44.3 x 230 (W x H x D) EPL-CW220-DN125	1	10	990 323 510	52,60	C
	End plate CW-P 320 – DN 125 dimensions: 320 x 44.3 x 230 (W x H x D) EPL-CW320-DN125	1	10	990 323 511	65,60	C
	End plate CW-P 320 – DN 150 dimensions: 320 x 44.3 x 230 (W x H x D) EPL-CW320-DN150	1	10	990 323 562	67,30	C
	End plate CW-P 320 – DN 160 dimensions: 320 x 44.3 x 230 (W x H x D) EPL-CW320-DN160	1	10	990 323 512	67,30	C
	End plate CW-P 420 – DN 160 dimensions: 420 x 44.3 x 230 (W x H x D) EPL-CW420-DN160	1	10	990 323 627	72,80	C
	End plate CW-P 420 – DN 180 dimensions: 420 x 44.3 x 230 (W x H x D) EPL-CW420-DN180	1	-	990 323 628	77,30	C
	End plate CW-P 420 – DN 200 dimensions: 420 x 44.3 x 230 (W x H x D) EPL-CW420-DN200	1	-	990 323 629	81,90	C
	End plate CW-P 520 – DN 160 dimensions: 520 x 44.3 x 230 (W x H x D) EPL-CW520-DN160	1	10	990 323 564	78,10	C
	End plate CW-P 520 – DN 200 dimensions: 520 x 44.3 x 230 (W x H x D) EPL-CW520-DN200	1	10	990 323 514	86,00	C
	End plate CW-P 625 – DN 160 dimensions: 625 x 44.3 x 230 (W x H x D) EPL-CW625-DN160	1	-	990 323 637	83,70	C
	End plate CW-P 625 – DN 180 dimensions: 625 x 44.3 x 230 (W x H x D) EPL-CW625-DN180	1	-	990 323 638	85,30	C
	End plate CW-P 625 – DN 200 dimensions: 625 x 44.3 x 230 (W x H x D) EPL-CW625-DN200	1	-	990 323 639	81,90	C

Air distribution manifolds

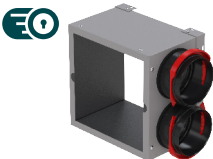
Product	Description	PU 1	PU 2	Article no.	Gross price €	Discount group
	<p>Module manifold box, 4-port for supply and extract air system with 4 x ComfoTube 90 connectors, including mounting bracket, locking slide and access cover. Connectors and access cover are interchangeable. Powder-coated RAL 7040 version. dimensions (excluding connector): 227.5 x 227.5 x 254 (H x W x L)</p> <p>DN 160 with Zehnder RapidLock[®] DIS-DN160-4DN90-RLC</p>	1	20	990 323 061	261,40	C
	<p>Module manifold box, 6-port for supply and extract air system with 6 x ComfoTube 90 connectors, including mounting bracket, locking slide and access cover. Connectors and access cover are interchangeable. Powder-coated RAL 7040 version dimensions (excluding connector): 227.5 x 227.5 x 396 (H x W x L)</p> <p>DN 160 with Zehnder RapidLock[®] DIS-DN160-6DN90-RLC</p>	1	20	990 323 062	398,30	C
	<p>Extension module, 2-port for module manifold box with 2 x ComfoTube 90 connectors, including locking slide and angle bracket, with Zehnder RapidLock[®] Powder-coated RAL 7040 version DIS-DIV-2DN90-RLC</p>	1	40	990 323 064	133,40	C
	<p>Extension module, 4-port for module manifold box with 4 x ComfoTube 90 connectors, including locking slide and angle bracket, with Zehnder RapidLock[®] Powder-coated RAL 7040 version DIS-DIV-4DN90-RLC</p>	1	20	990 323 065	174,10	C

Modular plastic in- and onfloor manifold box Zehnder ComfoCube Flex



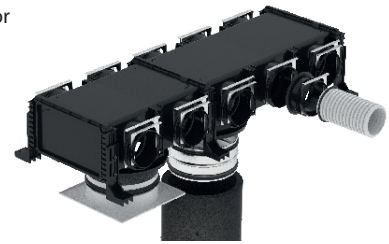

Modular plastic in- and onfloor manifold box Zehnder ComfoCube Flex suitable for connection of air ducts for intake and exhaust air up to 300 m³/h.

The manifold box can be assembled from single modules according your needs. The single modules will be connected on-site with clamping strips.











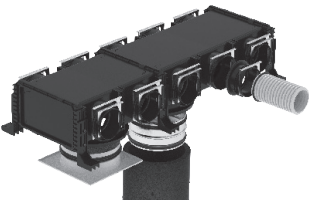
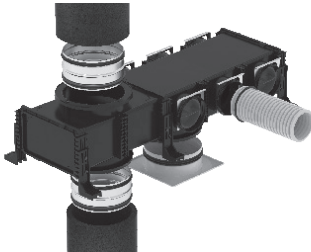
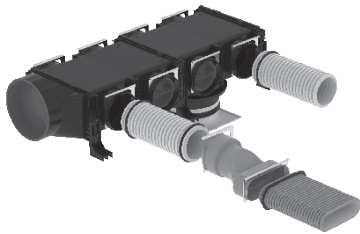



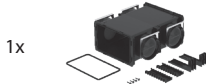

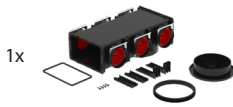

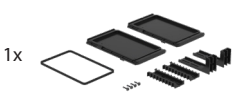
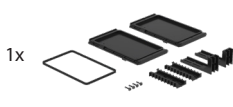

Product	Description	PU 1	PU 2	Article no.	Gross price €	Discount group
Modular plastic in- and onfloor manifold box Zehnder ComfoCube Flex						
	ComfoCube Flex module 4xDN90, incl. 1 set of clamping strips, 1 set of mounting brackets, 1 module sealing, 4 end caps DN90 & 4 fixing sliders Minimum installation depth: 162 mm dimensions: 300 x 284 x 134mm MOD-CCF-3/3+3-DN90-SET	1	-	990 323 370	86,20	C
	ComfoCube Flex module 4xDN90 with DN160 connection possibility DN160 connection possible from below or as access area incl. 1 set of clamping strips, 1 set of mounting brackets, 1 module sealing, 4 end caps DN90, 4 fixing sliders & 1 DN160 end cap Minimum installation depth: 162 mm dimensions: 300 x 284 x 134mm MOD-CCF-2/2+2/B-DN90-SET	1	-	990 323 371	113,60	C
	ComfoCube Flex module 6xDN90 incl. 1 set of clamping strips, 1 set of mounting brackets, 1 module sealing, 6 end caps DN90 & 6 fixing sliders Minimum installation depth: 162 mm dimensions: 450 x 284 x 134mm MOD-CCF-3/3+3-DN90-SET	1	-	990 323 372	95,10	C
	ComfoCube Flex module 6xDN90 with DN160 connection possibility DN160 connection possible from below or as access area incl. 1 set of clamping strips, 1 set of mounting brackets, 1 module sealing, 6 end caps DN90, 6 fixing sliders & 1 DN160 end cap Minimum installation depth: 162 mm dimensions: 450 x 284 x 134mm MOD-CCF-3/3+3/B.O-DN90-SET	1	-	990 323 373	122,40	C
	ComfoCube Flex shaft module DN160 for top or bottom connection, incl. 1 set of clamping strips, 1 set of mounting brackets, 1 module sealing & 2 DN160 end caps dimensions: 300 x 284 x 134 mm MOD-CCF-2/0+0/B.B-SET	1	-	990 323 374	97,20	C
	ComfoCube Flex frontal connection set DN160 with end plate Outer diameter 160 mm, inner diameter 150mm, incl. 1 set of clamping strips, 1 set of mounting brackets & 1 module sealing Note: Sealing needs to be done via cold shrink film EPL-CCF-L230-W135-H13-SPG-DN160-SET	1	-	990 323 375	44,40	C
	ComfoCube Flex end plate set for bottom connections incl. 1 set of clamping strips, 1 set of mounting brackets and 1 module sealing EPL-CCF-L230-W135-H13-2PC-SET	1	14	990 323 376	42,40	C

Modular plastic in- and onfloor manifold box Zehnder ComfoCube Flex



Product	Description	PU 1	PU 2	Article no.	Gross price €	Discount group
Accessories						
	Switchover connector DN 90 to ComfoTube 75 for reduction from DN 90 to ComfoTube 75, incl. 2 O-rings and 2 fixing de- vices, with Zehnder RapidLock®					
	1 piece TRA-CON-90/75-RLC	1	-	990 322 010	16,40	C
	10 pieces TRA-CON-90/75-10PC-RLC	1	10	990 322 009	112,90	C
	Junction 90 / 75 to flat 51 for connecting to ComfoTube flat 51 and ComfoTube 90 / 75, including 3 O-rings and 3 locking slides. TRA-DN90/75/FL51	1	10	990 322 013	12,92	C
	Note: for direct connection to the manifold box a 120 mm piece of Zeh- der ComfoTube 90 is required.					
	Reducer DN 160 CON-SEL-DN160-N	1	250	990 326 331	10,90	C
	Reducer DN 160/150 TRA-SEL-DN160/150-N	1	60	990 326 346	24,50	C
	Reducer DN 160/125 TRA-SEL-DN160/125-N	1	-	990 326 336	22,20	C

Overview combination examples ComfoCube Flex

 <p>Manifold 10x ComfoTube 75 with bottom connection and bottom access area DN160</p>	 <p>Manifold 6x ComfoTube 90 with riser shaft module DN160 and bottom access area DN160</p>	 <p>Manifold 4x ComfoTube 90 and 4x ComfoTube flat 51 with side connection DN160 and bottom access area DN160</p>
<p>1x</p> 		<p>1x</p> 
<p>1x</p> 		<p>1x</p> 
<p>1x</p> 	<p>1x</p> 	
<p>1x</p> 	<p>1x</p> 	
<p>1x</p> 	<p>1x</p> 	
<p>10x</p> 		<p>1x</p> 
<p>10x</p> 		<p>1x</p> 
<p>10x</p> 		<p>1x</p> 
<p>1x</p> 	<p>2x</p> 	
<p>1x</p> 	<p>2x</p> 	



Silencers

Product	Description	PU 1	PU 2	Article no.	Gross price €	Discount group
	Flexible silencer					
	DN 125 length excluding connector 1000 mm, flexible SIL-DN125-L1000-FLEX	1	12	990 318 031	102,70	C
	DN 160 length excluding connector 1000 mm, flexible SIL-DN160-L1000-FLEX	1	12	990 318 033	122,90	C
	DN 200 length excluding connector 1000 mm, flexible SIL-DN200-L1000-FLEX	1	12	990 318 035	164,60	C
	For Zehnder ComfoWell silencers, see page 50 onwards					
 	CSI rigid silencer highly efficient, special sound absorption material					
	CSI 350 DN 125 centric dimensions (L x W x D) 700 x 281 x 197 mm SIL-CSI350-DN125/125-L700	1	16	990 318 243	405,30	C
	CSI 350 DN 160 centric dimensions (L x W x D) 700 x 281 x 197 mm SIL-CSI350-DN160/160-L700	1	16	990 318 245	357,30	C
	CSI 550 DN 180 eccentric dimensions (L x W x D) 900 x 350 x 232 mm SIL-CSI550-DN180/180-L900-EXC	1	16	990 318 241	828,20	C
	CSI 550 DN 200 centric dimensions (L x W x D) 700 x 350 x 230 mm SIL-CSI550-DN200/200-L700	1	20	990 318 251	758,20	C

Insulated Air distribution system



ComfoTube Therm



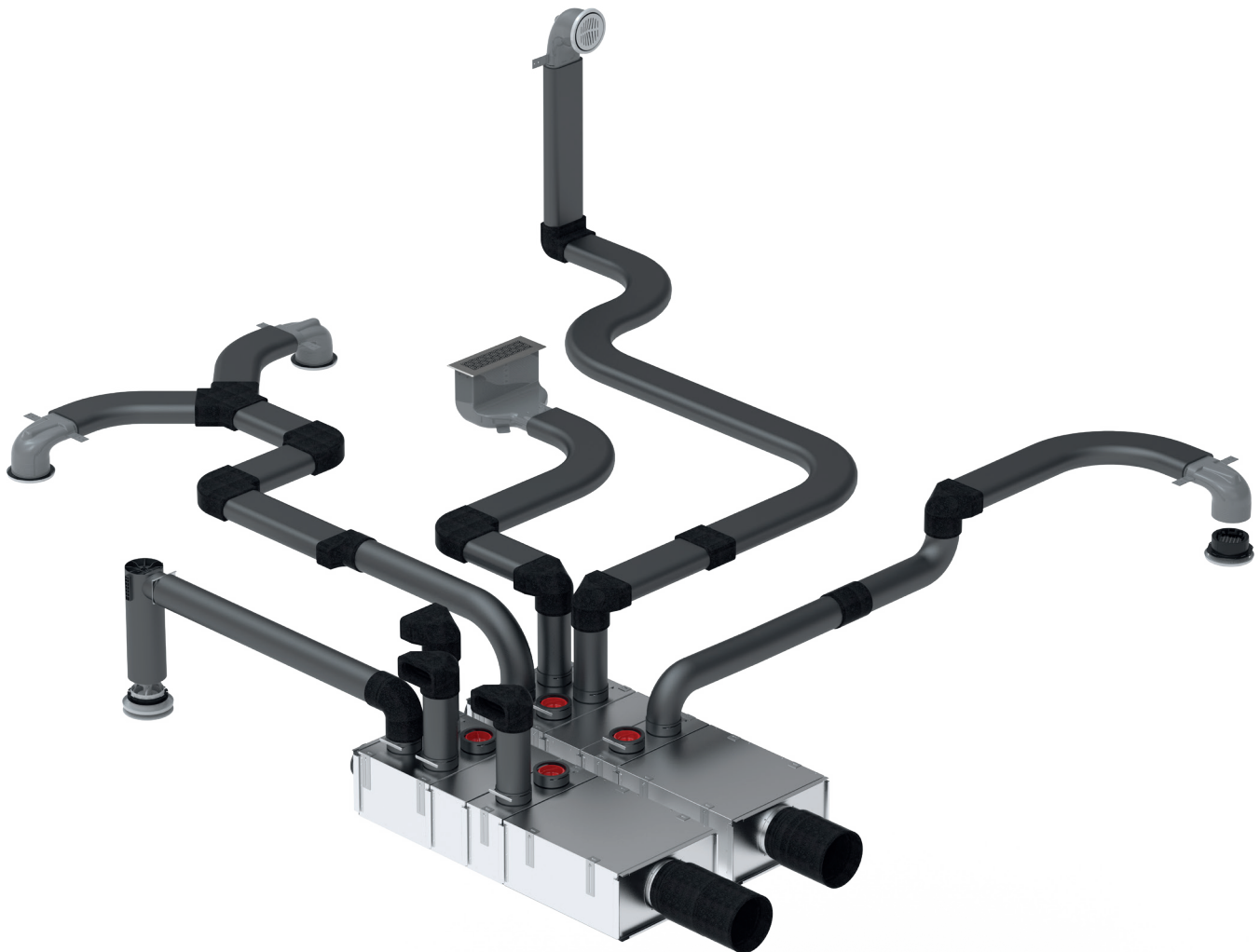





The Zehnder ComfoTube Therm insulated ventilation tube impresses with optimum sound and heat insulation properties for the perfect feel-good climate at home. This makes the ComfoTube Therm the ideal solution for the condensation-free transport of warm and cold air. Thanks to high-quality insulation, the temperature-controlled air is passed through the ventilation tube with almost no temperature loss, so that living spaces can be cooled and heated as required in an energy-efficient manner. The Zehnder ComfoFit Therm insulated connectors, made of expanded polypropylene (EPP), complete the portfolio to form a continuously insulated air distribution system, which is a component of the Zehnder ComfoClima room climate system solution.



Insulated Air distribution system

Product	Description	PU 1	PU 2	Article no.	Gross price €	Discount group
ComfoTube Therm						
	ComfoTube Therm 90 Insulated round tube, 20 m roll TUB-CTT-DN90-20m	1	-	990 328 030	453,35	CO
	ComfoTube Therm Flat 51 Insulated flat tube, 10 m roll TUB-CTT-FL51-20m	1	-	990 328 032	315,12	CO
ComfoFit Therm - Connectors						
	ComfoFit Therm connection sleeve 90 CON-CFT-DN90-M	1	-	990 430 855	19,70	CO
	ComfoFit Therm bend 90 EN-CFT-DN90x90-HOR	1	-	990 430 856	43,40	CO
	ComfoFit Therm sleeve Flat 51 CON-CFT-FL51-M	1	-	990 430 854	25,20	CO
	ComfoFit Therm bend Flat 51, horizontal BEN-CFT-FL51x90-HOR	1	-	990 430 851	32,00	CO
	ComfoFit Therm bend Flat 51, vertical BEN-CFT-FL51x90-VER	1	-	990 430 850	31,30	CO
	ComfoFit Therm Y-piece Flat 51 YPI-CFT-FL51/FL51/FL51	1	-	990 430 853	61,60	CO
	ComfoFit Therm junction 90 to Flat 51 TRA-CFT-FL51/DN90	1	-	990 430 857	34,10	CO
	ComfoFit Therm junction 90 to Flat 51, 90° bend TRA-CFT-FL51/DN90x90	1	-	990 430 852	30,30	CO
	Rubber seal ComfoTube Therm 90 SEL-CT-DN90-10PC	1	100	990 328 363	16,73	C
	End cap ComfoTube Therm 90 CAP-CT-DN90-10PC	1	10	990 328 263	54,30	C

Insulated Air distribution system

Product	Description	PU 1	PU 2	Article no.	Gross price €	Discount group
ComfoWell Therm 420						
	ComfoWell Therm Silencer DN 160 SIL-CWT420-DN160	1	-	990 430 867	394,04	CO
	Comfo Well Therm Silencer DN 200 SIL-CWT420-DN200	1	-	990 430 871	394,04	CO
	ComfoWell Therm extension module 4x90 DIS-CWT420-4DN90	1	-	990 430 860	211,04	CO
	ComfoWell Therm extension module 2x90 DIS-CWT420-2DN90	1	-	990 430 858	149,77	CO
	ComfoWell Therm extension module DIS-CWT420	1	-	990 430 859	134,50	CO
	ComfoWell Therm mounting plate 5x90 MPL-CWT420-5DN90-INS	1	-	990 430 863	153,92	CO
	ComfoWell Therm closed plate EPL-CWT420-BLI	1	-	990 430 861	68,70	CO
	ComfoWell Therm end plate DN 160 EPL-CWT420-DN160-INS	1	-	990 430 862	74,30	CO
	ComfoWell Therm end plate DN 200 EPL-CWT420-DN200-INS	1	-	990 430 870	74,30	CO
	ComfoWell Therm end cap 90 CAP-CWT-DN90-2PC	1	-	990 430 865	8,80	CO

InFloor air distribution

Product	Description	PU 1	PU 2	Article no.	Gross price €	Discount group
	ComfoTube 75 ventilation tube made of special PE, highly flexible, easy to clean, with inner skin, Ø 75 mm					
	20 m TUB-CT-DN75-20m	1	10	990 328 001	95,74	D
	50 m TUB-CT-DN75-50m	1	6	990 328 007	203,31	D
	ComfoTube 90 ventilation tube made of special PE, highly flexible, easy to clean, with inner skin, Ø 90 mm					
	20 m TUB-CT-DN90-20m	1	8	990 328 010	112,62	D
	50 m TUB-CT-DN90-50m	1	5	990 328 009	232,15	D
	Click sleeve for installation-friendly ComfoTube connection					
	Click sleeve DN 75 CON-CT-DN75-M	1	-	990 328 107	10,20	C
	Click sleeve DN 90 CON-CT-DN90-M	1	50	990 328 109	11,40	C
	End cap for ComfoTube to protect against dirt during construction 10 pieces					
	End cap DN 75 CAP-CT-DN75-10PC	1	10	990 328 262	44,10	C
	End cap DN 90 CAP-CT-DN90-10PC	1	10	990 328 263	54,30	C
	O-ring seal for sealing ComfoTube sleeve 10 pieces					
	O-ring seal DN 75 SEL-CT-DN75-10PC	1	100	990 328 362	16,73	C
	O-ring seal DN 90 SEL-CT-DN90-10PC	1	100	990 328 363	16,73	C
	Cable tie 7.5 x 360 mm for fastening ventilation tubes 100 pieces MAC-CT-L365-100PC	1	50	990 327 820	29,20	C
	ComfoTube 75 tube holder for fastening ventilation tubes, with integrated locking and stacking function 10 pieces MAC-DN75-HLD-10PC	1	74	990 327 200	26,70	C
	ComfoTube 90 tube holder for fastening ventilation tubes, with integrated locking and stacking function 10 pieces MAC-DN90-HLD-10PC	1	47	990 327 201	30,90	C



InFloor air distribution

Product	Description	PU 1	PU 2	Article no.	Gross price €	Discount group
	ComfoTube 90° bend for narrow bends in the ComfoTube pipeline, bend can be shortened and thus used directly in the mounting plate, including 2 locking slides					
	for ComfoTube 75 with Zehnder RapidLock® BEN-CT-DN75x90-RLC	1	22	990 322 152	23,80	C
	for ComfoTube 90 with Zehnder RapidLock® BEN-CT-DN90x90-RLC	1	22	990 322 153	28,00	C
	Junction 90 / 75 to flat 51 for connecting to ComfoTube flat 51 and ComfoTube 90 / 75, including 3 O-rings and 3 locking slides TRA-DN90/75/FL51	1	10	990 322 013	12,92	C
	Junction 90 to flat 51, 90° bend for 90° vertical rerouting, connects to ComfoTube flat 51 and ComfoTube 90, including 2 O-rings and 2 locking slides TRA-FL51/DN90x90	1	20	990 322 046	16,38	C
	ComfoFit junction 2 x 75 to flat 51 to connect to ComfoTube flat 51 and ComfoTube 75, including 3 O-rings and 3 locking slides, with Zehnder RapidLock® TRA-CT-FL51/2DN75-RLC	1	20	990 322 150	21,40	C
	ComfoTube 75/90 cross-piece for crossing ComfoTube 75/90 TRA-ADJ-4xDN90/75	1	5	990 322 155	56,20	C
	ComfoSet 75 airflow regulator for ComfoTube 75 RES-CT-CS-DN75	1	25	990 320 026	15,00	C
	ComfoSet 90 airflow regulator for ComfoTube 90 RES-CT-CS-DN90	1	25	990 320 027	17,70	C
	5-port connector 90 for airtight connection of 2 x ComfoTube 90 CON-CT-5DN90	1	20	990 326 905	185,00	C

InFloor air distribution

Product	Description	PU 1	PU 2	Article no.	Gross price €	Discount group
Grille housing TVA-P						
	TVA-P 75 grille housing for connecting valve DN 125 to ComfoTube 2 x DN 75, including guard, mounting bracket, locking slide Connection length = 64 mm OUT-TVA/P-2DN75-Z-DN125-H150-COV-MB	1	12	990 326 121	48,35	C
	For designer grilles, see overview on page 75/76.					
	TVA-P 75 grille housing for connecting valve DN 125 to ComfoTube 2 x DN 75, including guard, mounting bracket, locking slide Connection length = 300 mm OUT-TVA/P-2DN75-Z-DN125-H385-COV-MB	1	10	990 326 125	48,35	C
	For designer grilles, see overview on page 75/76.					
	TVA-P 90 grille housing for connecting valve DN 125 to ComfoTube 1 x DN 90, including guard, mounting bracket, locking slide Connection length = 64 mm OUT-TVA/P-DN90-Z-DN125-H165-COV-MB	1	16	990 326 122	48,35	C
	For designer grilles, see overview on page 75/76.					
	TVA-P 90 grille housing for connecting valve DN 125 to ComfoTube 1 x DN 90, including guard, mounting bracket, locking slide Connection length = 300 mm OUT-TVA/P-DN90-Z-DN125-H400-COV-MB	1	10	990 326 126	48,35	C
	For designer grilles, see overview on page 75/76.					
	TVA-P 90 grille housing for connecting valve DN 125 / design grille to ComfoTube 2 x DN 90, including guard, mounting bracket, locking slide and o-ring Connection length = 300 mm OUT-TVA/P-2DN90-Z-DN125-H400-COV-MB	1	-	990 320 725	72,90	C
	For designer grilles, see overview on page 75/76.					
	TVA-P 90 frontal for connecting valve DN 125 / design grille to ComfoTube 1 x DN 90, including guard, mounting bracket, locking slide Connection length = 160 mm OUT-TVA/P-DN90-DN125-C-COV	1	10	990 326 136	61,40	C
	For designer grilles, see overview on page 75/76.					
	Mounting set DN 125 for securing grille housing to the concrete framework TVA-P 75 (990 326 121) and TVA-P 90 (990 326 122) including attachment nails MAC-TVA/P-DN125-MF-SET	1	-	990 326 127	14,70	C
	Extension 160 mm for TVA-P grille housing and CLRf DN125 EXT-TVA-CLRf-DN125	1	10	990 326 137	39,30	C

InFloor air distribution

Product	Description	PU 1	PU 2	Article no.	Gross price €	Discount group
Grille housing CLD-P						
	Grille housing CLD-P 75 for connecting to ComfoTube DN 75, including guard, mounting bracket, distance plate and locking slide Height = 85 mm , frontal sleeve OUT-CLD/P-DN75-A-H85-DS-MAC For designer grilles, see overview on page 75/76.	1	30	990 320 810	128,90	C
	Grille housing CLD-P 75 for connecting to ComfoTube DN 75, including guard, mounting bracket, distance plate and locking slide Height = 85 mm, lateral sleeve OUT-CLD/P-DN75-B-H85-DS-MAC Height = 115 mm, lateral sleeve OUT-CLD/P-DN75-B-H115-DS-MAC For designer grilles, see overview on page 75/76.	1	24	990 320 811	138,20	C
		1	30	990 320 813	138,20	C
	Grille housing CLD-P 90 for connecting to ComfoTube DN 90, including guard, mounting bracket, distance plate and locking slide Height = 115 mm , frontal sleeve OUT-CLD/P-DN90-A-H115-DS-MAC For designer grilles, see overview on page 75/76.	1	36	990 320 845	138,20	C
	Grille housing CLD-P 90 for connecting to ComfoTube DN 90, including guard, mounting bracket, distance plate and locking slide Height = 115 mm, lateral sleeve OUT-CLD/P-DN90-B-H115-DS-MAC Height = 140 mm, lateral sleeve OUT-CLD/P-DN90-B-H140-DS-MAC For designer grilles, see overview on page 75/76.	1	30	990 320 846	146,50	C
		1	20	990 320 852	146,50	C





InFloor air distribution

Product	Description	PU 1	PU 2	Article no.	Gross price €	Discount group
Grille housing CLD with direct WC connection						
	Grille housing CLD 90 with direct WC connection for connecting to ComfoTube DN 90/ DN 50, with Zehnder RapidLock® Height = 115 mm, frontal sleeve. Including 4 m ComfoTube 50 OUT-CLD-DN90-A-H115-WC-CT50-4M-SET-RLC For designer grilles, see overview on page 75/76.	1	-	990 320 553	146,50	C
	Telescopic frame for floor installation, CLD 60 – 95 mm FRA-DGR-FLO-L260-W160-H60/95 90 – 160 mm FRA-DGR-FLO-L260-W160-H90/160 155 – 230 mm FRA-DGR-FLO-L260-W160-H155/230	1	40	990 320 370	99,40	C
	Replacement filter for extract air housing CLD 10 pieces FIL-CLD-L158-W113-H9-CRS-45%-10PC-WHITE	1	540	990 320 575	53,34	B
Grille housing CLD-P wide						
	Grille housing CLD-P 75 wide for connecting to ComfoTube 3 x DN 75 Height = 115 mm, lateral connectors with Zehnder RapidLock® OUT-CLD-3DN75-B-RLC-H115	1	70	990 320 533	241,10	C
	Grille housing CLD-P 90 wide for connecting to ComfoTube 2 x DN 90 Height = 115 mm, lateral connectors with Zehnder RapidLock® OUT-CLD-2DN90-B-RLC-H115 Height = 140 mm, lateral connectors with Zehnder RapidLock® OUT-CLD-2DN90-B-RLC-H140 For designer grilles, see overview on page 75.	1	70	988 320 507	220,50	C
		1	70	988 320 527	220,50	C
Installation accessories for grille housing CLD wide						
	Telescopic frame for floor installation CLD wide 60 – 95 mm FRA-DGR-FLO-L430-W160-H60/95 155 – 230 mm FRA-DGR-FLO-L430-W160-H155/230	1	-	988 320 370	227,30	C
		1	-	988 320 369	246,40	C
	Replacement filter for extract air housing CLD, ISO Coarse ≥ 45 % 10 pieces Two filters are required for CLD wide FIL-CLD-L158-W113-H9-CRS-45%-10PC-WHITE	1	540	990 320 575	53,34	B

InFloor air distribution

Product	Description	PU 1	PU 2	Article no.	Gross price €	Discount group
Inductive vents						
	Slot diffuser ComfoGrid Linea 400 for supply and extract air, wall and ceiling mounting (not suitable for floor mounting), suitable for housing CSB-P 400. Dimensions: 436 x 76,5 mm					
	ComfoGrid Linea 400 Black, glas optics, black DGR-CSB/P-L400-W75-Linea-Black	1	-	990 321 790	205,73	C
	ComfoGrid Linea 400 White, glas optics, white DGR-CSB/P-L400-W75-Linea-White	1	-	990 321 791	205,73	C
	ComfoGrid Linea 400 Inox, stainless steel DGR-CSB/P-L400-W75-Linea-Inox	1	-	990 321 792	168,92	C
	Slot diffuser ComfoGrid Linea 600 for supply and extract air, wall and ceiling mounting (not suitable for floor mounting), suitable for housing CSB-P 600. Dimensions: 636 x 76,5 mm					
	ComfoGrid Linea 600 Black, glas optics, black DGR-CSB/P-L600-W75-Linea-Black	1	-	990 321 793	253,80	C
	ComfoGrid Linea 600 White, glas optics, white DGR-CSB/P-L600-W75-Linea-White	1	-	990 321 794	253,80	C
	ComfoGrid Linea 600 Inox, stainless steel DGR-CSB/P-L600-W75-Linea-Inox	1	-	990 321 795	204,81	C
	Slot diffuser ComfoGrid Lamina for supply and extract air, wall and ceiling mounting (not suitable for floor mounting), adjustable air outlet angle, suitable for housing CSB-P 400 and 600.					
	ComfoGrid Lamina 400, aluminum, Dimension 436 x 76,5 mm DGR-CSB-L400-W75-Lamina-ALU	1	10	990 321 740	185,90	C
	ComfoGrid Lamina 600, aluminum, Dimension 636 x 76,5 mm DGR-CSB-L600-W75-Lamina-ALU	1	10	990 321 760	202,00	C
	Slot diffuser ComfoGrid Bilamina for supply and extract air, wall and ceiling mounting (not suitable for floor mounting), double sided air intake for evenly, barely noticeable inflow, suitable for housing CSB-P 400 and 600.					
	ComfoGrid Bilamina 400, aluminum, Dimension 445 x 83 mm DGR-CSB-L400-W75-Bilamina-ALU	1	10	990 321 640	185,90	C
	ComfoGrid Bilamina 600, aluminum, Dimension 645 x 83 mm DGR-CSB-L600-W75-Bilamina-ALU	1	10	990 321 660	202,00	C
	ComfoCase CSB-P 400 for slot diffuser ComfoGrid Linea, Lamina and Bilamina, for connection to 2 x round tube Zehnder ComfoTube 75 or 1 x round tube Zehnder ComfoTube 90, wall- and ceiling mounting possible (not suitable for floor mounting), lateral connection. Height = 182 mm OUT-CSB/P-2DN75-DN90-B-L410	1	-	990 321 745	67,50	C
	ComfoCase CSB-P 600 for connection to 2 x round tube Zehnder ComfoTube 90 or 1 x round tube Zehnder ComfoTube 110 (ComfoTube 110 and components on request), wall and ceiling mounting (not suitable for floor mounting), lateral connection. Height = 182 mm OUT-CSB/P-2DN90-DN110-B-L610	1	-	990 321 746	99,23	C

InFloor air distribution

Product	Description	PU 1	PU 2	Article no.	Gross price €	Discount group
Inductive vents						
	ComfoSet 75 short for housing CSB-P 400 and 600 air flow restricter for ComfoTube 75 RES-CT-CS-DN75-L30	1	25	988 320 030	15,10	C
	ComfoSet 90 short for housing CSB-P 400 and 600 air flow restricter for ComfoTube 90 RES-CT-CS-DN90-L30	1	25	988 320 031	18,00	C
	Mounting bracket for housing CSB-P 400 and 600 for wall mounting and suspended ceilings. Content: 2 pieces MAC-CSB-MB	1	-	988 321 646	61,90	C
	Switchover connector DN 90 auf ComfoTube 75 for housing CSB-P 600, for reduction from DN 90 to ComfoTube 75, incl. 2 O-rings and 2 fixing devices, with Zehnder RapidLock® TRA-CON-90/75-RLC	1	-	990 322 010	16,40	C
	Filter set for housing CSB-P 400 for use in extract air mode, ISO Coarse ePM1 ≥ 55 % (G3), Content: 10 pieces FIL-CSB/P-L410-W55-CRS-55%-10PC	1	-	990 321 768	73,20	B
	Filter set for housing CSB-P 600 for use in extract air mode, ISO Coarse ePM1 ≥ 55 % (G3), Content: 10 pieces FIL-CSB/P-L610-W55-CRS-55%-10PC	1	-	990 321 769	102,32	B
ComfoDuct overflow element						
	ComfoDuct overflow element for air connection between rooms, including sound absorption elements; two designer grilles are required (not included in the scope of delivery)					
	for wall thicknesses of 80 – 140 mm OUT-CD-H80/140	1	18	990 324 052	150,70	C
	for wall thicknesses of 140 – 260 mm OUT-CD-H140/260	1	20	990 324 053	150,70	C
	For designer grilles, see page 75 onwards					

OnFloor air distribution

Product	Description	PU 1	PU 2	Article no.	Gross price €	Discount group
OnFloor air distribution						
	Twin duct CK 300 for connecting unit distribution manifolds to walls, floors and ceilings, length 1,5 m TUB-CK300-1,5m	1	37	990 322 020	59,10	C
	CK 300 flexible element for flexible connection to twin duct CK 300 including a lip seal. Used as flexible bend (up to 45°) and as height offset for twin duct CK 300 CON-CK300-FLEX	1	12	990 328 821	41,30	C
	ComfoFit CK 300 for connecting twin duct CK 300, including 4 lip seals CON-CK300-N	1	10	990 322 023	18,70	C
	Twin duct bend CK 300 H for horizontal 90° bend, including 4 lip seals BEN-CK300x90-HOR	1	10	990 322 021	29,00	C
	Twin duct bend CK 300 V for vertical 90° bend, including 4 lip seals BEN-CK300x90-VER	1	10	990 322 022	24,90	C
	Junction CK 300 / DN 160 adapter for twin duct CK 300 to pipe DN 160, including 2 lip seals TRA-DN160/CK300	1	5	990 322 025	43,80	C
	Junction CK 300 / DN 125 adapter for twin duct CK 300 to pipe DN 125, including 2 lip seals TRA-DN125/CK300	1	35	990 322 029	43,80	C
	Twin duct cap CK 300 end cap to protect against dirt during construction, for twin duct CK 300 CAP-CK300	1	136	990 322 024	8,20	C
	Lip seal CK 300 for CK 300 duct, 10 pieces SEL-CK300-10PC	1	10	990 322 026	39,60	C
	flat 51 6-port manifold for supply or extract air system, with 6 ComfoTube flat 51 connectors, including 6 O-rings and 6 locking slides, with access panel DIS-6FL51	1	10	990 322 030	191,54	C
	flat 51 4-port manifold for supply or extract air system, with 4 ComfoTube flat 51 connectors, including 4 O-rings and 4 locking slides, with access panel DIS-4FL51	1	10	990 322 031	120,35	C
	Manifold flat 51, 4-port with single connection, for supply air or extract air with 4 ComfoTube flat 51 connectors, including 4 O-rings and 4 locking slides, with access panel. Suitable for use as left-hand and right-hand version, convertible DIS-4FL51-1CK300	1	50	990 328 823	162,80	C
	Manifold connector DN 160 6-port for flat 6-port manifold directly to pipe DN 160 EPL-6FL51-DN160	1	10	990 322 037	172,40	C
	Stacking frame with cover for 6-port manifold assembly 50 – 80 mm / in floor FRA-DIS-FLO-6FL51-H50/80	1	60	990 322 042	139,70	C
	80 – 130 mm / in floor FRA-DIS-FLO-6FL51-H80-130	1	60	990 322 043	143,70	C
	Stacking frame with cover for 4-port manifold assembly 50 – 80 mm / in floor FRA-DIS-FLO-4FL51-H50/80	1	80	990 322 040	125,40	C







OnFloor air distribution

Product	Description	PU 1	PU 2	Article no.	Gross price €	Discount group
	ComfoTube flat 51 ventilation tube made from PE easy to clean, with smooth inner skin, 51 x 138 mm					
	20 m TUB-CT-FL51-20m	1	8	990 328 002	240,12	D
	50 m TUB-CT-FL51-50m	1	4	990 328 063	586,27	D
	2 m TUB-CT-FL51-2m	1	-	990 328 080	38,10	D
	flat 51 sleeve for installation-friendly ComfoTube connection, including locking slide and O-ring CON-CT-FL51-M	1	57	990 322 014	13,38	C
	Bend flat 51 H for horizontal 90° bend, connects to ComfoTube flat 51, including 2 O-rings and 2 locking slides BEN-FL51x90-HOR	1	15	990 322 012	20,08	C
	Bend flat 51 V for vertical 90° bend, connects to ComfoTube flat 51, including 2 O-rings and 2 locking slides BEN-FL51x90-VER	1	36	990 322 011	18,35	C
	Junction 90 / 75 to flat 51 for connecting to ComfoTube flat 51 and ComfoTube 90 / 75, including 3 O-rings and 3 locking slides TRA-DN90/75/FL51	1	10	990 322 013	12,92	C
	Junction 90 to flat 51, 90° bend for vertical 90° bend, connection to ComfoTube flat 51 and ComfoTube 90, including 2 O-rings and 2 locking slides TRA-FL51/DN90x90	1	20	990 322 046	16,38	C
	Junction 2 x 75 to flat 51 for connecting to ComfoTube flat 51 and ComfoTube 75, including 3 O-rings and 3 locking slides TRA-CT-FL51/2DN75	1	20	990 322 150	21,40	C
	Y piece flat 51 for branch, connection to ComfoTube flat 51, including 3 O-rings and 3 locking slides, air volume max. 45 m³/h at normal ventilation level YPI-FL51/FL51/FL51	1	14	990 322 151	41,30	C
	Cross-piece flat 51 for crossing flat 51, including 4 O-rings and 4 locking slides TRA-ADJ-4xFL51	1	9	990 322 154	60,60	C
	End cap flat 51 for ComfoTube 51 to protect against dirt during installation 10 pieces CAP-CT-FL51-10PC	1	10	990 328 252	51,69	C
	Mounting bracket flat 51 10 pieces MAC-FL51-MB-10PC	1	50	990 322 016	34,96	C

OnFloor air distribution

Product	Description	PU 1	PU 2	Article no.	Gross price €	Discount group
OnFloor air distribution ComfoAir Fit 100						
	Duct system CK150/300 for connection of the ventilation unit to the distribution manifolds. As single channel the maximum air flow is 150 m ³ /h and 300 m ³ /h as double channel. ComfoMain CK150/300 twin duct, L=1,5m Not suitable for concreting, for unit to manifold connection on wall, floor and ceiling. Set contains two single ducts CK150 TUB-CK150-1,5M-2PC	1	12	990 322 051	59,10	C
	ComfoMain CK150/300 twin duct, L=1m Suitable for concreting, for unit to manifold connection on wall, floor and ceiling. Set contains two single ducts CK150 TUB-CK150-1M-2PC	1	12	990 322 052	66,92	C
	CK 300 flexible element for flexible connection to twin duct CK 300 including a lip seal. Used as flexible bend (up to 45°) and as height offset for twin duct CK 300 CON-CK300-FLEX	1	12	990 328 821	41,30	C
	ComfoFit CK 300 for connecting twin duct CK 300, including 4 lip seals CON-CK300-N	1	10	990 322 023	18,70	C
	Twin duct bend CK 300 H for horizontal 90° bend, including 4 lip seals BEN-CK300x90-HOR	1	10	990 322 021	29,00	C
	ComfoFit CK 300 twin duct bend H for horizontal 45° bend, including 4 lip seals BEN-CK300x45-HOR	1	10	990 322 050	29,50	C
	Twin duct bend CK 300 V for vertical 90° bend, including 4 lip seals BEN-CK300x90-VER	1	10	990 322 022	24,90	C
	Junction CK 300 / DN 160 adapter for twin duct CK 300 to pipe DN 160, including 2 lip seals TRA-DN160/CK300	1	5	990 322 025	43,80	C
	Junction CK 300 / DN 125 adapter for twin duct CK 300 to pipe DN 125, including 2 lip seals TRA-DN125/CK300	1	35	990 322 029	43,80	C
	ComfoFit junction CK300/DN 160 adapter for twin duct CK300 to pipe DN 160, for vertical 90° bend, including 2 lip seals TRA-DN160/CK300x90	1	10	990 322 049	73,04	C







OnFloor air distribution

Product	Description	PU 1	PU 2	Article no.	Gross price €	Discount group
	Twin duct cap CK 300 end cap to protect against dirt during construction, for twin duct CK 300 CAP-CK300	1	136	990 322 024	8,20	C
	Lip seal CK 300 for CK 300 duct, 10 pieces SEL-CK300-10PC	1	10	990 322 026	39,60	C
	ComfoFit transition T-piece CK150 duct to ComfoTube 90, incl. sealing ring and RapidLock® ComfoTube 90 connection TRA-CK150/CT90/CK150-RLC	1	10	990 322 053	76,00	C
	ComfoWell End plate CW220 - CK150 for connection of CK150/300 duct system to ComfoWell Dimensions: 220 x 40 x 230 mm (W x H x D) EPL-CW220-CK150	1	10	990 322 540	52,00	C
	ComfoCube CK150 manifold 5xDN75 for exhaust or supply air systems. With five ComfoTube 75 connections and one CK300 twin duct single connection (CK150), with RapidLock®. Dimensions: 380 x 270 mm incl. connections DIS-CK150-5CT75-RLC	1	10	990 323 076	145,60	C
	ComfoCube CK150 manifold 4xDN90 for exhaust or supply air systems. With four ComfoTube 90 connections and one CK300 twin duct single connection (CK150), with RapidLock®. Height: 106 mm Dimensions: 270 x 270 mm incl. connections DIS-CK150-4CT90-RLC	1	10	990 430 831	120,00	C

OnFloor air distribution

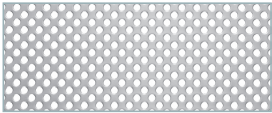
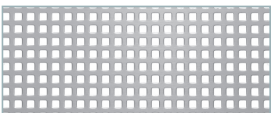
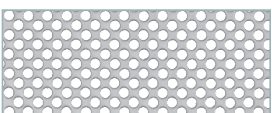

Product	Description	PU 1	PU 2	Article no.	Gross price €	Discount group
	ComfoSet flat 51 air flow regulator RES-CT-CS-FL51	1	25	990 322 015	25,10	C
	Grille housing CLF for wall, floor or ceiling installation, connection for ComfoTube flat 51, including O-ring and locking slide OUT-CLF-FL51 For designer grilles, see overview on page 75/76.	1	10	990 322 000	41,88	C
	CLRF round grille housing, lateral connects to ComfoTube flat 51 with 90° bend, for wall and ceiling mounting, including O-ring and locking slide OUT-CLRF-FL51-Z-DN125 For designer grilles, see overview on page 76.	1	10	990 322 060	41,65	C
	CLRF round grille housing, lateral 2x connection to ComfoTube flat 51 OUT-CLRF-2FL51-Z_DN125 For designer grilles, see overview on page 76.	1	10	990 322 063	53,65	C
	Round grille housing CLRF, frontal straight connection to ComfoTube flat 51 bend, for wall and ceiling installation, including O-ring and locking slide OUT-CLRF-FL51-C-DN125 For designer grilles, see overview on page 76.	1	12	990 322 061	41,65	C
	Cutting templates to protect the finished wall or floor space when cutting the vents. Set of cutting templates, CLF and CLRF, 3 pieces MAC-CLF/CLRF-CUT-SET	1	-	990 322 094	90,00	B
Renovation valves						
	Grille housing for refurbishment valve for connecting refurbishment valve to ComfoTube flat 51 Length = 400 mm, eccentric OUT-REN-FL51-L400	1	32	990 322 062	39,40	C
	Grille housing for refurbishment valve for connecting refurbishment valve to ComfoTube 1 x DN 90 Length = 400 mm, centric OUT-REN-DN90-L400	1	32	990 320 062	39,40	C
	High-induction refurbishment supply air valve, round DN 90, Ø = 105 mm, suitable for grille housing 990 320 062 and 990 322 062 Plastic, white DGR-REN-DN90-D105-9016	1	280	990 326 254	15,23	C
	Refurbishment extract air valve, square DN 90, 180 x 112 mm, suitable for grille housing 990 320 062 and 990 322 062 Plastic, white DGR-REN-DN90-L180-W112-9016	1	232	990 326 253	29,19	C

Overview of InFloor and OnFloor designer grilles

Grill housing		CLD-P		CLD wide		CLF	
		 Designer grilles from page 77		 Designer grilles from page 78		 Designer grilles from page 80	
Designer grilles		Stainless steel	White	Stainless steel	White	Stainless steel	White
Roma		990 320 610	990 320 611*	990 320 617	990 320 618*	990 322 081	990 322 080*
Pisa		990 320 620	990 320 621*	990 320 624	990 320 627*	990 322 083	990 322 082*
Torino		990 320 630	990 320 631*	990 320 634	990 320 636*	990 322 085	990 322 084*
Venezia		990 320 640	990 320 641*	990 320 648	990 320 647*	990 322 087	990 322 086*
Genua		990 320 660*	990 320 661*	990 320 662*	990 320 663*		

* Not suitable for floor installation

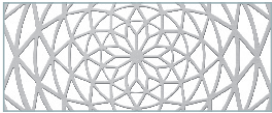
Overview of round and square InFloor and OnFloor designer grilles

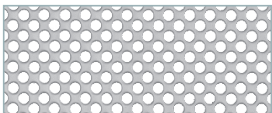
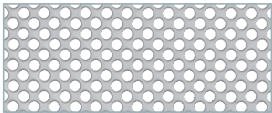
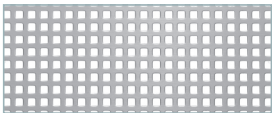
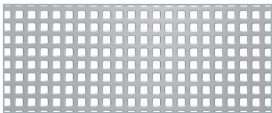
Grill housing	TVA-P		CLRF	
	Designer grilles from page 81		Designer grilles from page 81	
Designer grilles	Stainless steel	White	Stainless steel	White
Sans soucis round 	990 322 116	990 322 117	990 322 116	990 322 117
Sacré coeur round 	990 322 118	990 322 119	990 322 118	990 322 119
Venezia round 	990 320 780	990 320 781	990 320 780	990 320 781
Venezia square 	990 322 089	990 322 090	990 322 089	990 322 090
Torino round 	990 320 790	990 320 791	990 320 790	990 320 791
Torino square 	990 322 088	990 320 792	990 322 088	990 320 792







Supply air valve			
ComfoValve Luna S125 	705 613 126*	705 613 126*	

* Bulk pack of 24, see page 82

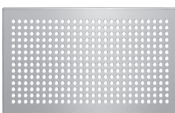
Extract air valve			
ComfoValve Luna E125 with filter 	705 613 127	705 613 127	
ComfoValve Luna E125 without filter	705 613 128*	705 613 128*	

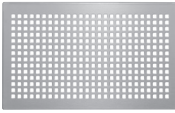
* Bulk pack of 24, see page 82





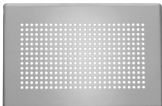
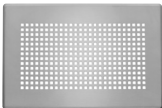
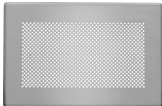

InFloor designer grilles

Product	Description	PU 1	PU 2	Article no.	Gross price €	Discount group
 <p>Zehnder Roma</p>	Supply and extract air designer grille dimensions: 260 x 160 mm, suitable for CLD-P, CLD-WC for installation in walls, ceilings and floors					
	ComfoGrid Roma decorative grille, stainless steel DGR-CLD-L260-W160-Roma-INOX	1	20	990 320 610	51,70	C
	ComfoGrid Roma decorative grille, RAL 9016 (not suitable for use as a floor grille) DGR-CLD-L260-W160-Roma-9016	1	20	990 320 611	51,70	C
 <p>Zehnder Pisa</p>	Supply and extract air designer grille dimensions: 260 x 160 mm, suitable for CLD-P, CLD-WC for installation in walls, ceilings and floors					
	ComfoGrid Pisa decorative grille, stainless steel DGR-CLD-L260-W160-Pisa-INOX	1	20	990 320 620	51,70	C
	ComfoGrid Pisa decorative grille, RAL 9016 (not suitable for use as a floor grille) DGR-CLD-L260-W160-Pisa-9016	1	20	990 320 621	51,70	C
 <p>Zehnder Torino</p>	Supply and extract air designer grille dimensions: 260 x 160 mm, suitable for CLD-P, CLD-WC for installation in walls, ceilings and floors					
	ComfoGrid Torino decorative grille, stainless steel DGR-CLD-L260-W160-Torino-INOX	1	20	990 320 630	51,70	C
	ComfoGrid Torino decorative grille, RAL 9016 (not suitable for use as a floor grille) DGR-CLD-L260-W160-Torino-9016	1	20	990 320 631	51,70	C
 <p>Zehnder Venezia</p>	Supply and extract air designer grille dimensions: 260 x 160 mm, suitable for CLD-P, CLD-WC for installation in walls, ceilings and floors					
	ComfoGrid Venezia decorative grille, stainless steel DGR-CLD-L260-W160-Venezia-INOX	1	20	990 320 640	51,70	C
	ComfoGrid Venezia decorative grille, RAL 9016 (not suitable for use as a floor grille) DGR-CLD-L260-W160-Venezia-9016	1	20	990 320 641	51,70	C
 <p>Zehnder Genua</p>	Supply and extract air designer grille dimensions: 260 x 160 mm, suitable for CLD-P, CLD-WC for installation in walls and ceilings, not for floors					
	ComfoGrid Genua decorative grille, stainless steel (not suitable for use as a floor grille) DGR-CLD-L260-W160-Genua-INOX	1	20	990 320 660	51,70	C
	ComfoGrid Genua decorative grille, RAL 9016 (not suitable for use as a floor grille) DGR-CLD-L260-W160-Genua-9016	1	20	990 320 661	51,70	C
	Telescopic frame for floor installation, CLD-P, CLD-WC					
	60 – 95 mm FRA-DGR-FLO-L260-W160-H60/95	1	40	990 320 370	99,40	C
	90 – 160 mm FRA-DGR-FLO-L260-W160-H90/160	1	40	990 320 371	110,20	C
	155 – 230 mm FRA-DGR-FLO-L260-W160-H155/230	1	40	990 320 373	123,80	C



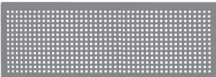

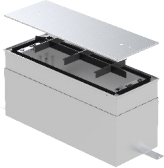

InFloor designer grilles

Product	Description	PU 1	PU 2	Article no.	Gross price €	Discount group
 <p>Zehnder Roma</p>	<p>Designer grille for supply air with 20 mm edge covering dimensions: 300 x 200 mm, suitable for CLD-P and CLD-WC, for installation in floors</p> <p>ComfoGrid Roma decorative grille, stainless steel DGR-CLD-L300-W200-Roma-INOX</p>	1	20	990 320 612	57,70	C
 <p>Zehnder Torino</p>	<p>Designer grille for supply air with 20 mm edge covering dimensions: 300 x 200 mm, suitable for CLD-P and CLD-WC, for installation in floors</p> <p>ComfoGrid Torino decorative grille, stainless steel DGR-CLD-L300-W200-Torino-INOX</p>	1	20	990 320 632	57,70	C
 <p>Zehnder Venezia</p>	<p>Designer grille for supply air with 20 mm edge covering dimensions: 300 x 200 mm, suitable for CLD-P and CLD-WC, for installation in floors</p> <p>ComfoGrid Venezia decorative grille, stainless steel DGR-CLD-L300-W200-Venezia-INOX</p>	1	20	990 320 642	57,70	C





InFloor designer grilles

Product	Description	PU 1	PU 2	Article no.	Gross price €	Discount group
 Zehnder Pisa	Supply and extract air designer grille dimensions: 430 x 160 mm, suitable for CLD wide, for installation in walls, ceilings and floors					
	ComfoGrid Pisa decorative grille, stainless steel DGR-CLD-L430-W160-Pisa-INOX	1	10	990 320 624	65,90	C
	ComfoGrid Pisa decorative grille, RAL 9016 (not suitable for use as a floor grille) DGR-CLD-L430-W160-Pisa-9016	1	10	990 320 627	65,90	C
 Zehnder Venezia	Supply and extract air designer grille dimensions: 430 x 160 mm, suitable for CLD wide, for installation in walls, ceilings and floors					
	ComfoGrid Venezia decorative grille, stainless steel DGR-CLD-L430-W160-Venezia-INOX	1	10	990 320 648	65,90	C
	ComfoGrid Venezia decorative grille, RAL 9016 (not suitable for use as a floor grille) DGR-CLD-L430-W160-Venezia-9016	1	10	990 320 647	65,90	C
 Zehnder Roma	Supply and extract air designer grille dimensions: 430 x 160 mm, suitable for CLD wide, for installation in walls, ceilings and floors					
	ComfoGrid Roma decorative grille, stainless steel DGR-CLD-L430-W160-Roma-INOX	1	10	990 320 617	65,90	C
	ComfoGrid Roma decorative grille, RAL 9016 (not suitable for use as a floor grille) DGR-CLD-L430-W160-Roma-9016	1	10	990 320 618	65,90	C
 Zehnder Torino	Supply and extract air designer grille dimensions: 430 x 160 mm, suitable for CLD wide, for installation in walls, ceilings and floors					
	ComfoGrid Torino decorative grille, stainless steel DGR-CLD-L430-W160-Torino-INOX	1	10	990 320 634	65,90	C
	ComfoGrid Torino decorative grille, RAL 9016 (not suitable for use as a floor grille) DGR-CLD-L430-W160-Torino-9016	1	10	990 320 636	65,90	C
 Zehnder Genua	Supply and extract air designer grille dimensions: 430 x 160 mm, suitable for CLD wide, for installation in walls and ceilings, not for floors					
	ComfoGrid Genua decorative grille, stainless steel (not suitable for use as a floor grille) DGR-CLD-L430-W160-Genua-INOX	1	10	990 320 662	65,90	C
	ComfoGrid Genua decorative grille, RAL 9016 (not suitable for use as a floor grille) DGR-CLD-L430-W160-Genua-9016	1	10	990 320 663	65,90	C
	Telescopic frame for floor installation CLD wide					
	60 – 95 mm FRA-DGR-FLO-L430-W160-H60/95	1	-	988 320 370	227,30	C
	155 – 230 mm FRA-DGR-FLO-L430-W160-H155/230	1	-	988 320 369	246,40	C
	Replacement filter for extract air housing CLD-P and CLD-WC ISO Coarse ≥ 45 % 10 pieces Two filters are required for CLD wide FIL-CLD-L158-W113-H9-CR5-45%-10PC-WHITE	1	540	990 320 575	53,34	B

OnFloor designer grilles

Product	Description	PU 1	PU 2	Article no.	Gross price €	Discount group
 <p>Zehnder Roma</p>	Supply and extract air designer grille dimensions: 350 x 130 mm, suitable for CLF, for installation in walls, ceilings and floors					
	ComfoGrid Roma decorative grille, stainless steel DGR-CLF-L350-W130-Roma-INOX ComfoGrid Roma decorative grille, RAL 9016 (not suitable for use as a floor grille) DGR-CLF-L350-W130-Roma-9016	1	10	990 322 081	69,20	C
 <p>Zehnder Pisa</p>	Supply and extract air designer grille dimensions: 350 x 130 mm, suitable for CLF, for installation in walls, ceilings and floors					
	ComfoGrid Pisa decorative grille, stainless steel DGR-CLF-L350-W130-Pisa-INOX ComfoGrid Pisa decorative grille, RAL 9016 (not suitable for use as a floor grille) DGR-CLF-L350-W130-Pisa-9016	1	10	990 322 083	69,20	C
 <p>Zehnder Torino</p>	Supply and extract air designer grille dimensions: 350 x 130 mm, suitable for CLF, for installation in walls, ceilings and floors					
	ComfoGrid Torino decorative grille, stainless steel DGR-CLF-L350-W130-Torino-INOX ComfoGrid Torino decorative grille, RAL 9016 (not suitable for use as a floor grille) DGR-CLF-L350-W130-Torino-9016	1	10	990 322 085	69,20	C
 <p>Zehnder Venezia</p>	Supply and extract air designer grille dimensions: 350 x 130 mm, suitable for CLF, for installation in walls, ceilings and floors					
	ComfoGrid Venezia decorative grille, stainless steel DGR-CLF-L350-W130-Venezia-INOX ComfoGrid Venezia decorative grille, RAL 9016 (not suitable for use as a floor grille) DGR-CLF-L350-W130-Venezia-9016	1	10	990 322 087	69,20	C
	ComfoGrid CLF decorative grille, RAL 9016 plastic dimensions: 330 x 110 mm, suitable for CLF, for installation in walls, ceilings and floors, white plastic DGR-CLF-L350-W110-Plastic-9016	1	25	990 322 001	23,60	C
	Cross-bracing floor insert for designer grille CLF MAC-DGR/CLF-FLO	1	20	990 322 095	16,20	C
	Filter set CLF, ISO Coarse ≥ 30 % 10 pieces FIL-CLF-L295-W75-CRS-30%-10PC	1	70	990 322 100	70,48	B



Round InFloor and OnFloor designer grilles

Product	Description	PU 1	PU 2	Article no.	Gross price €	Discount group
 Zehnder Sans soucis	Round designer grille, extract air with filter, connector DN 125, suitable for CLRF / TVA, Ø 160 mm, for installation in walls and ceilings, not for floors ComfoGrid Sans soucis, stainless steel (not suitable for use as a floor grille) DGR-DIV-DN125/160-FIL-Sans_soucis-INOX	1	10	990 322 116	131,50	C
	ComfoGrid Sans soucis, RAL 9016 (not suitable for use as a floor grille) DGR-DIV-DN125/160-FIL-Sans_soucis-9016	1	10	990 322 117	131,50	C
 Zehnder Sacré coeur	Round designer grille, extract air with filter, connector DN 125, suitable for CLRF / TVA, Ø 160 mm, for installation in walls and ceilings, not for floors ComfoGrid Sacré coeur, stainless steel (not suitable for use as a floor grille) DGR-DIV-DN125/160-FIL-Sacre_coeur-INOX	1	10	990 322 118	131,50	C
	ComfoGrid Sacré coeur, RAL 9016 (not suitable for use as a floor grille) DGR-DIV-DN125/160-FIL-Sacre_coeur-9016	1	10	990 322 119	131,50	C
 Zehnder Venezia	Round designer grille, extract air with filter, connector DN 125, suitable for CLRF / TVA, Ø 160 mm, for installation in walls and ceilings, not for floors ComfoGrid Venezia, stainless steel (not suitable for use as a floor grille) DGR-DIV-DN125/160-FIL-Venezia-INOX	1	10	990 320 780	51,10	C
	ComfoGrid Venezia, RAL 9016 (not suitable for use as a floor grille) DGR-DIV-DN125/160-FIL-Venezia-9016	1	10	990 320 781	51,10	C
 Zehnder Torino	Round designer grille, extract air with filter, connector DN 125, suitable for CLRF / TVA, Ø 160 mm, for installation in walls and ceilings, not for floors ComfoGrid Torino, stainless steel (not suitable for use as a floor grille) DGR-DIV-DN125/160-FIL-Torino-INOX	1	10	990 320 790	51,10	C
	ComfoGrid Torino, RAL 9016 (not suitable for use as a floor grille) DGR-DIV-DN125/160-FIL-Torino-9016	1	10	990 320 791	51,10	C
 Zehnder Venezia	Square designer grille, extract air with filter, connector DN 125, suitable for CLRF / TVA, 160 x 160 mm, for installation in walls and ceilings, not for floors ComfoGrid Venezia, stainless steel (not suitable for use as a floor grille) DGR-DIV-DN125/L160-W160-FIL-Venezia-INOX	1	10	990 322 089	51,10	C
	ComfoGrid Venezia, RAL 9016 (not suitable for use as a floor grille) DGR-DIV-DN125-Q160-FIL-Venezia-9016	1	10	990 322 090	51,10	C
 Zehnder Torino	Square designer grille, extract air with filter, connector DN 125, suitable for CLRF / TVA, 160 x 160 mm, for install ComfoGrid Torino, stainless steel DGR-DIV-DN125-Q160-FIL-Torino-INOX	1	10	990 322 088	51,10	C
	ComfoGrid Torino, RAL 9016 DGR-DIV-DN125-Q160-FIL-Torino-9016	1	10	990 320 792	51,10	C
	Filter set DN 125, ISO Coarse ≥ 45 % suitable for extract air valves and designer grilles CLRF / TVA 10 pieces FIL-DIV-DN125-CRS-45%-10PC	1	20	990 320 032	29,88	B

InFloor and OnFloor valves

Product	Description	PU 1	PU 2	Article no.	Gross price €	Discount group
     	Supply air valve ComfoValve Luna S125 DN 125, Ø 170, suitable for CLRF / TVA-P Plastic, white VAL-SUP-LUN1-DN125-PLS-9003	1	-	705 613 126	40,15	C
	Supply air valve ComfoValve Luna S125 - bulk pack of 24 DN 125, Ø 170, suitable for CLRF / TVA-P, plastic, white (bulk pack of 24) VAL-SUP-LUN1-DN125-PLS-9003-24PC	1	-	705 613 125	806,40	C
	Supply air valve ComfoValve Luna S125 DN 125, Ø 170, suitable for CLRF / TVA-P Plastic, black VAL-SUP-LUN1-DN125-PLS-black	1	-	705 613 135	44,90	C
	AirBlocker outflow restrictor suitable for ComfoValve Luna S125, for restricting the outflow angle to 240° RES-LUN1-DN125	1	-	705 613 001	14,30	C
	Extract valve STC 100/125 DN 100/125, Ø 150, suitable for CLRF / TVA, plastic, white VAL-ETA-STC-DN100/125	1	40	705 051 021	16,00	C
	Filter set DN 125, ISO Coarse ≥ 45 % (G3) suitable for extract air valves and designer grilles CLRF / TVA 10 pieces FIL-DIV-DN125-CRS-45%-10PC	1	20	990 320 032	29,88	B

Service

Product	Description	Article no.	Gross price €	Discount group
	Air distribution cleaning set suitable for ComfoTube 75 / 90 and flat 51. Including adapter for grille housing CLD(-P), CLF, CLRF and TVA(-P) as well as vacuum cleaner connectors, reel length 15 metres UTL-BRU-SET	990 000 106	2.002,90	B
	ComfoTool Pipe cutter ComfoTube DN75 / DN90 UTL-CT-DN75/90	990 000 110	31,10	C
	CO ₂ data logger for measuring and recording carbon dioxide, air temperature and humidity in closed interiors. Including time and date display, plug, USB data cable, PC software. MEQ-CO2	990 000 100	203,80	net











Zehnder outdoor and exhaust air



90 – 97

Overview of components for outdoor air and exhaust air connectors	90
Overview of connection components for brine-earth heat exchangers	91
ComfoFond-L Q brine-earth heat exchangers	92
ComfoVent facade system	94
Outdoor air and exhaust air connectors	97

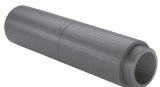



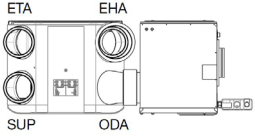
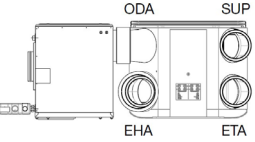

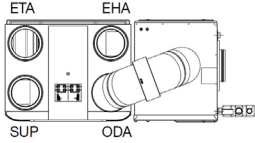
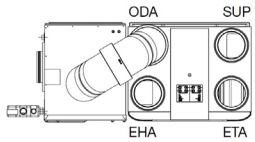
Overview of components for outdoor air and exhaust air connectors									
Outdoor air/ exhaust air connector	External wall grille 125	Roof housing 125	External wall grille 160	Roof housing 160	Roof housing 160	External wall grille 180	ComfoVent 180	External wall grille 200	Roof housing 200
Connection line									
Aluminium lined flexible duct 125 	Direct	Direct							
Aluminium lined flexible duct 160 			Direct	Direct	Connection nipple DN 160 990 326 331				
Aluminium lined flexible duct 200 								Direct	Direct
ComfoPipe Compact 125 	Direct	Direct							
ComfoPipe Compact 160 			Direct	Direct	Connection nipple DN 160 990 326 331		Adapter with condensation drain 990 430 737		
ComfoPipe Compact 200 							Adapter with condensation drain 990 430 738	Direct	Direct
ComfoPipe Plus 160 			Direct	Direct	Connection nipple DN 160 990 326 331		Adapter with condensation drain 990 430 737		
ComfoPipe Plus 200 						Junction 990 430 739	Adapter with condensation drain 990 430 738 Junction 990 430 739	Direct	Direct

Overview of connection components for brine-earth heat exchangers		
	ComfoAir Q350/450 TR	ComfoAir Q600 ST
Aluminium lined flexible duct 160 	 ComfoPipe 160 / 180 junction 990 328 664	 ComfoPipe 160 / 180 junction 990 328 664
Aluminium lined flexible duct 180 	Direct	Direct
ComfoPipe Compact 160 	ComfoPipe Compact 160/180 junction 990 328 664	ComfoPipe Compact 160/180 junction 990 328 664
ComfoPipe Compact 200 		ComfoPipe Compact 180 x 200 junction 990 326 341
ComfoPipe Plus 160 	ComfoPipe Plus Connector set 990 328 750	
ComfoPipe Plus 200 		ComfoPipe Plus Connector set 990 328 751

Brine-earth heat exchangers

Product	Description	PU 1	PU 2	Article no.	Gross price €	Discount group
ComfoFond-L Q						
	<p>ComfoFond-L Q TR brine-earth heat exchanger including upstream filter G4 and complete hydraulics for up to 450 m³/h supply air volume flow rate</p> <p>Accessories required: ComfoAir Q350/450/600 option box, dry siphon 5/4"</p>					
	<p>ComfoFond-L Q L TR brine-earth heat exchanger for ComfoAir Q350/450 TR on left CF-LIQ-CAQ-L-SLN</p>	1	-	471 310 082	2.492,80	B
	<p>ComfoFond-L Q R TR brine-earth heat exchanger for ComfoAir Q350/450 TR on right CF-LIQ-CAQ-R-SLN</p>	1	-	471 310 083	2.492,80	B
	<p>ComfoFond-L Q ST brine-earth heat exchanger including prefilter G4, complete hydraulics and connecting bend for up to 600 m³/h supply air volume flow rate</p> <p>Accessories required: ComfoAir Q350/450/600 option box, dry siphon 5/4"</p>					
	<p>ComfoFond-L Q L ST brine-earth heat exchanger for ComfoAir Q600 ST on left CF-LIQ-CAQ-L-STT</p>	1	-	471 310 084	2.806,20	B
	<p>ComfoFond-L Q R ST brine-earth heat exchanger for ComfoAir Q600 ST on right CF-LIQ-CAQ-R-STT</p>	1	-	471 310 085	2.806,20	B

Brine-earth heat exchangers

Product	Description	PU 1	PU 2	Article no.	Gross price €	Discount group
ComfoFond-L Q accessories						
	Option Box ComfoAir Q350/450/600 for additional connection options for CO ₂ and humidity sensors as well as ComfoFond-L Q. ComfoFond-L Q only: When combined with ComfoFond-L Q, connection cable 400 300 311 needs to be ordered separately. OPB-CAQ-LIGHT VERSION-V2	1	-	471 502 143	223,00	C
	Connection cable for use of OptionBox combined with ComfoFond-L Q, lenght 2,5 m PSP-CAB-OPB-230V-10A-PCK	1	-	400 300 311	36,50	C
	ComfoFond-L Q TR floor stand height = 355 mm FRA-CF-LIQ-CAQ-SLN	1	-	471 310 086	224,60	B
	ComfoFond-L Q ST floor stand height = 315 mm FRA-CF-LIQ-CAQ-ST	1	-	471 310 087	224,60	B
	Dry siphon 5/4" for ComfoFond-L Q SIP-5/4"-CA350/550-CF-L	1	20	990 201 330	64,00	C
	Filter for ComfoFond-L Q, ISO Coarse ≥ 60 % (G4) 1 piece FIL-CRS-SPR-P	1	-	400 100 066	25,79	B

Example applications for the ComfoVent facade system

1 ComfoVent 180 System 1
above ground level

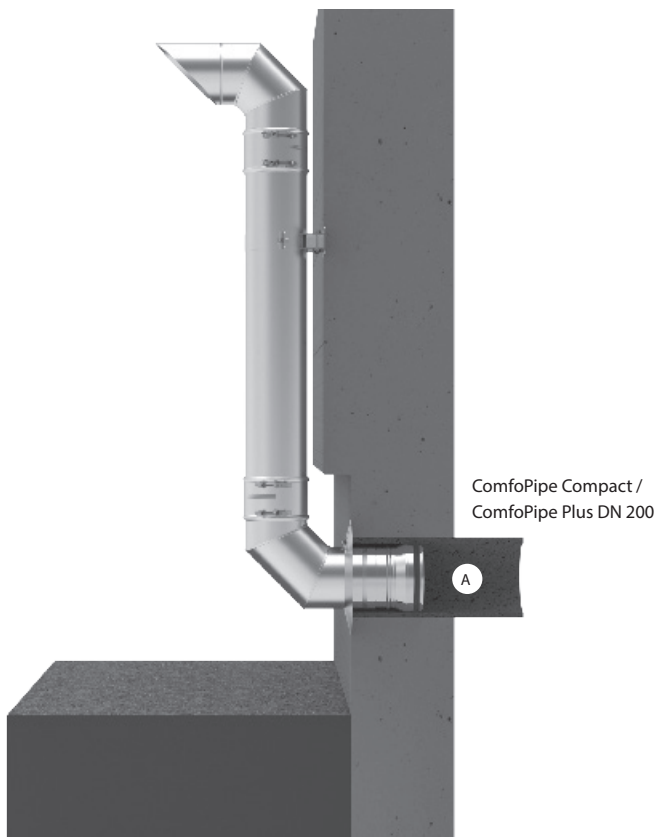

2 ComfoVent 180 System 2
under ground level

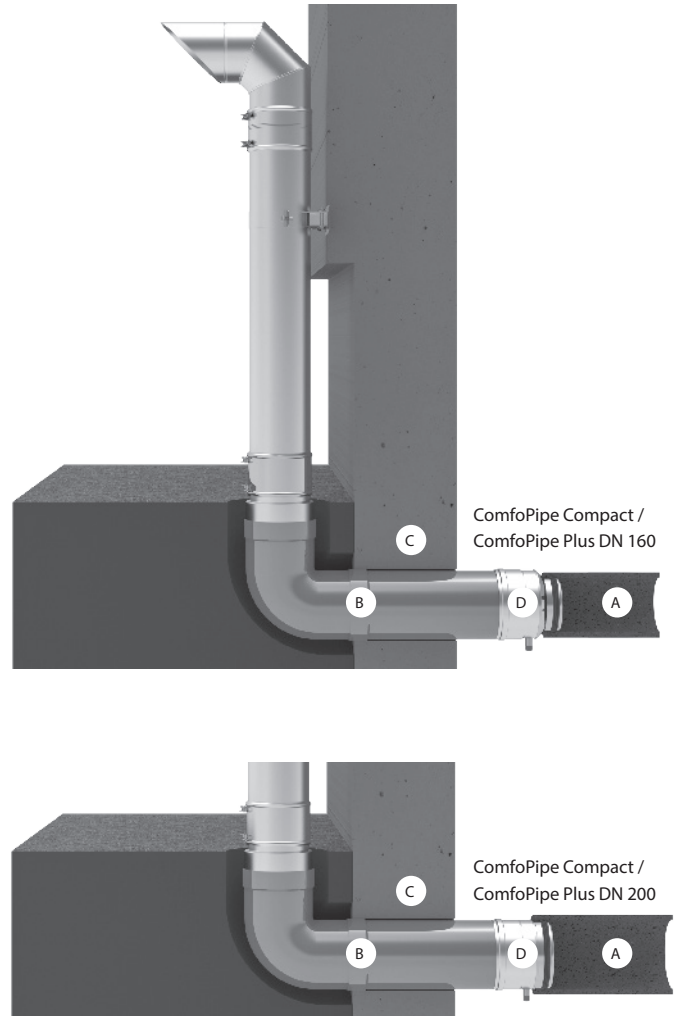

- A ComfoPipe Compact / ComfoPipe Plus
- B Underground line DN 200 (on site)
- C Wall duct, resistant to pressurised water if necessary (on site)
- D Condensation drain with adaptor for ComfoPipe Compact / ComfoPipe Plus





Facade system

Product	Description	PU 1	PU 2	Article no.	Gross price €	Discount group
ComfoVent						
	<p>Facade system 1 for air flow of the outdoor air or exhaust air above ground level and for connection to ComfoPipe Compact / Plus, material stainless steel</p> <p>Set consists of:</p> <ul style="list-style-type: none"> 1 x outdoor air bend (with seal and clamp fitting) 1 x length element L = 1080 mm (with seal and clamp fitting) 1 x 90° bend with seal 1 x wall bracket (adjustable 50-90 mm) 1 x adaptor DN 180 to ComfoPipe Compact / Plus DN 200 1 x wall rosette <p>ComfoVent 180 system 1 to ComfoPipe Compact / ComfoPipe Plus DN 200, above ground level EAC-CV-DN180/200-CPCP-SET1</p> <p>Note: Going through the wall, ComfoPipe Compact DN 200 (990 328 696) or ComfoPipe Plus DN 200 (990 328 720) must be used (not included). Is a connection DN 160 coming from the ventilation unit intended, a reduction adaptor (990 326 349) can be used as transition from ComfoPipe Compact / Plus DN 200 on to ComfoPipe Compact / Plus DN 160.</p>	1	2	990 430 740	971,80	C
	<p>Facade system 2 for air flow of the outdoor air or exhaust air via on-site plastic tube laid in the ground and for connection to ComfoPipe, material stainless steel</p> <p>Set consists of:</p> <ul style="list-style-type: none"> 1 x outdoor air bend (with seal and clamp fitting) 1 x length element L = 1080 mm (with seal and clamp fitting) 1 x junction to plastic tube DN 200 1 x condensate drain with adaptor to ComfoPipe Compact / ComfoPipe Plus with seal 1 x wall bracket (adjustable 50-90 mm) <p>ComfoVent 180 system 2 to ComfoPipe Compact / ComfoPipe Plus DN 160, below ground level EAC-CV-DN180/160-CPCP-SET2</p> <p>ComfoVent 180 system 2 to ComfoPipe Compact / ComfoPipe Plus DN 200, below ground level EAC-CV-DN180/200-CPCP-SET2</p> <p>Note: Earth-laid, hygienically safe, as air duct suitable plastic pipe DN 200 is not included in the scope of delivery and must be provided on site.</p>	1	2	990 430 741	971,80	C
		1	2	990 430 742	971,80	C











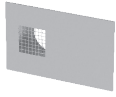

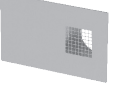

Facade system

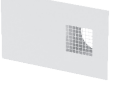
Product	Description	PU 1	PU 2	Article no.	Gross price €	Discount group
ComfoVent tube elements stainless steel with seal, clamp fitting D = 180 mm						
	ComfoVent length element 360 mm, stainless steel with seal, clamp fitting D = 180 mm TUB-CV-DN180-L360-INOX	1	12	990 430 706	125,80	C
	ComfoVent length element 540 mm, stainless steel with seal, clamp fitting D = 180 mm TUB-CV-DN180-L540-INOX	1	12	990 430 705	143,70	C
	ComfoVent length element 1080 mm, stainless steel with seal, clamp fitting D = 180 mm TUB-CV-DN180-L1080-INOX	1	18	990 430 704	190,40	C
	ComfoVent 90° bend D = 180 mm, stainless steel with seal, clamp fitting D = 180 mm BEN-CV-DN180X90-INOX	1	12	990 430 711	225,90	C
	Inlet/outlet unit made from stainless steel with clamp fitting and seal, suitable for outdoor air and exhaust air ComfoVent outdoor air bend D = 180 mm EAC-CV-DN180X90-INOX	1	12	990 430 718	405,30	C
	Wall rosette, stainless steel, suitable for covering wall cut-out Wall rosette 180 mm MAC-CV-DN180-WMO	1	-	990 430 731	49,20	C
Condensate drain made from stainless steel with seal, as a junction from on-site underground plastic tube DN 150 / DN 200 to ComfoPipe with drainage connector DN 15						
	ComfoVent converter 180 mm, stainless steel made of stainless steel, with sealing, as connection between ComfoVent (System 1) D = 180 mm and on-site ComfoPipe Compact / Plus tube DN 200 TRA-CV-DN180/200-M/N	1	32	990 430 739	168,40	C
	Condensate drain made of stainless steel, with sealing, with junction from on-site, earth-laid plastic pipe DN 200 on to ComfoPipe Compact / ComfoPipe Plus (system 2), with condensate drain connection DN 15 ComfoVent condensate drain DN200, stainless steel with junction on to ComfoPipe Compact / ComfoPipe Plus 160 TRA-CV-DN200/160-M/N	1	32	990 430 737	166,90	C
	ComfoVent condensate drain DN200, stainless steel with junction on to ComfoPipe Compact / ComfoPipe Plus 200 TRA-CV-DN200/200-M/N	1	32	990 430 738	166,90	C
	Clamp fitting for locking and sealing the connection Clamp fitting 180 mm, with adjustable quick fastener CON-CV-DN180	1	-	990 430 730	45,00	C
	Wall bracket, stainless steel for fastening the standpipes to the facade Wall bracket 180 mm, wall clearance 50 – 90 mm MAC-CV-DN180	1	-	990 430 732	143,70	C

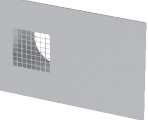

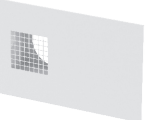

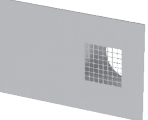
Facade system

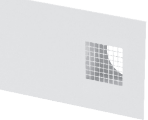
Product	Description	PU 1	PU 2	Article no.	Gross price €	Discount group
Outdoor air / exhaust air connector						
   	Roof housing for pitched roof DN 125 for roof pitches of 6° – 60° including universal roof tile, installation template, fastening material and sealing flange Colour: black, RAL 9005 EAC-ROH-DN125-6°/60°-9005	1	-	990 430 611	316,50	C
	Roof housing for pitched roof DN 160 for roof pitches of 6° – 60° including universal roof tile, installation template, fastening material and sealing flange Colour: red, RAL 8004 EAC-ROH-DN160-6°/60°-8004 Colour: black, RAL 9005 EAC-ROH-DN160-6°/60°-9005	1	-	990 430 612	629,80	C
	Roof housing for pitched roof DN 200 for roof pitches of 6° – 60° including universal roof tile, installation template, fastening material and sealing flange Colour: red, RAL 8004 EAC-ROH-DN200-6°/60°-8004 Colour: black, RAL 9005 EAC-ROH-DN200-6°/60°-9005	1	-	990 430 614	684,40	C
	Roof housing for pitched roof DN 200 for roof pitches of 6° – 60° including universal roof tile, installation template, fastening material and sealing flange Colour: red, RAL 8004 EAC-ROH-DN200-6°/60°-8004 Colour: black, RAL 9005 EAC-ROH-DN200-6°/60°-9005	1	-	990 430 615	684,40	C
	Roof housing for flat roof DN 160 black, with flat roof collar EAC-ROH-DN160-9005	1	-	990 430 604	387,80	C
	External wall grille for wall installation DN 125 up to 200 m ³ /h EAC-DN125-125M3H-L248-W267-H37-INOX DN 160 up to 450 m ³ /h EAC-DN160-350M3H-L280-W280-H37-INOX DN 200 up to 600 m ³ /h EAC-DN200-500M3H-L330-W330-H37-INOX	1	20	990 430 250	103,60	C
	DN 160 up to 450 m ³ /h EAC-DN160-350M3H-L280-W280-H37-INOX	1	20	990 430 584	108,90	C
	DN 200 up to 600 m ³ /h EAC-DN200-500M3H-L330-W330-H37-INOX	1	20	990 430 585	150,70	C

Facade system

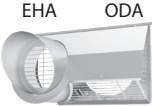
Product	Description	PU 1	PU 2	Article no.	Gross price €	Discount group
Outdoor air / exhaust air connector						
 	<p>Combined external ComfoEdge Dupla DN125 for compact connection of the outdoor and exhaust air in one element</p> <p>ComfoEdge Dupla combined external wall grille right, galvanised sheet steel connector DN 125, nominal air volume 120 m³/h EAC-DN125-EHA-ODA-R-Dupla-INOX</p>	1	-	990 430 573	261,60	C
 	<p>ComfoEdge Dupla combined external wall grille right, galv. sheet steel, RAL 9016 connector DN 125, nominal air volume 120 m³/h EAC-DN125-EHA-ODA-R-Dupla-9016</p>	1	-	990 430 571	273,90	C
 	<p>ComfoEdge Dupla combined external wall grille left, galvanised sheet steel connector DN 125, nominal air volume 120 m³/h EAC-DN125-EHA-ODA-L-Dupla-INOX</p>	1	-	990 430 572	261,60	C
 	<p>ComfoEdge Dupla combined external wall grille left, galv. sheet steel, RAL 9016 connector DN 125, nominal air volume 120 m³/h EAC-DN125-EHA-ODA-L-Dupla-9016</p>	1	-	990 430 570	273,90	C
 	<p>Combined external ComfoEdge Dupla DN 160 for compact connection of the outdoor and exhaust air in one element</p> <p>ComfoEdge Dupla combined external wall grille right, galvanised sheet steel connector DN 160, nominal air volume 270 m³/h EAC-DN160-EHA-ODA-R-Dupla-INOX</p>	1	-	990 430 577	351,90	C
 	<p>ComfoEdge Dupla combined external wall grille right, galv. sheet steel, RAL 9016 connector DN 160, nominal air volume 270 m³/h EAC-DN160-EHA-ODA-R-Dupla-9016</p>	1	-	990 430 575	368,30	C
 	<p>ComfoEdge Dupla combined external wall grille left, galvanised sheet steel connector DN 160, nominal air volume 270 m³/h EAC-DN160-EHA-ODA-L-Dupla-INOX</p>	1	-	990 430 576	351,90	C
 	<p>ComfoEdge Dupla combined external wall grille left, galv. sheet steel, RAL 9016 connector DN 160, nominal air volume 270 m³/h EAC-DN160-EHA-ODA-L-Dupla-9016</p>	1	-	990 430 574	368,30	C

Facade system

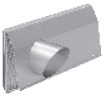
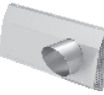
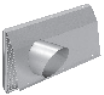
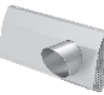
Product	Description	PU 1	PU 2	Article no.	Gross price €	Discount group
Outdoor air / exhaust air connector						
    See example installations on page 46	Combined external wall grille DN 125 for compact connection of the outdoor and exhaust air in one element					
	ComfoEdge combined external wall grille right, stainless steel connector DN 125 up to 200 m ³ /h nominal flow EAC-DN125-EHA-ODA-R-INOX	1	-	990 430 591	189,00	C
	ComfoEdge combined external wall grille right, stainless steel, RAL 9016 connector DN 125 up to 200 m ³ /h EAC-DN125-EHA-ODA-R-9016	1	-	990 430 599	205,50	C
	ComfoEdge combined external wall grille left, stainless steel connector DN 125 up to 200 m ³ /h nominal flow EAC-DN125-EHA-ODA-L-INOX	1	-	990 430 592	189,00	C
	ComfoEdge combined external wall grille left, stainless steel, RAL 9016 connector DN 125 up to 200 m ³ /h EAC-DN125-EHA-ODA-L-9016	1	-	990 430 598	205,50	C
 	Combined external wall grille DN 160 for compact connection of the outdoor and exhaust air in one element					
	Outdoor air connector right, connector DN 160 up to 300 m ³ /h nominal flow EAC-DN160-EHA-ODA-R-INOX	1	-	990 430 594	253,90	C
	Outdoor air connector left, connector DN 160 up to 300 m ³ /h nominal flow EAC-DN160-EHA-ODA-L-INOX	1	-	990 430 595	253,90	C
 	ComfoEdge combined external wall grille DN200 up to 400m ³ /h nominal air flow rate for compact connection of the outdoor air and exhaust air in one element. External dimensions: 676 x 337 x 212 mm Drill hole distance, centre to centre: 328.5 mm Ø Drill hole: min. 240 mm (ComfoPipe Compact), min. 290 mm (ComfoPipe Plus)					
	ComfoEdge combined external wall grille, DN200, exhaust air connection right, stainless steel EAC-DN200-EHA-ODA-R-INOX	1	12	990 430 596	317,40	C
	ComfoEdge combined external wall grille, DN200, exhaust air connection left, stainless steel EAC-DN200-EHA-ODA-L-INOX	1	12	990 430 597	317,40	C









Zehnder replacement filters

102 – 108

Replacement filters for ventilation units	102
Replacement filters for ventilation units, outdoor air intake, filter box	105
Replacement filters for heating elements, brine-earth heat exchangers, air distribution	107
Replacement filters for ComfoWell	108





















Replacement filters for ventilation units

Product	Description	PU 1	PU 2	Article no.	Gross price €	Discount group
ComfoSpot 50						
	 <p>Filter set for ComfoSpot 50, ISO Coarse $\geq 70\%$ (G4), 2 pieces FIL-CSP50-CRS/G4-2PC-PCK</p>	1	-	527 005 390	28,21	B
	 <p>Pollen filter set for ComfoSpot 50, ISO Coarse $\geq 70\%$ / ISO ePM10 $\geq 60\%$ (G4 / F7) 2 pieces FIL-CSP50-CRS/G4-ePM10/F7-2PC-PCK</p>	1	-	527 005 400	30,81	B
	 <p>Filter set for ComfoSpot 50, ISO Coarse $\geq 70\%$ (G4), 10 pieces FIL-CSP50-CRS/G4-10PC-PCK</p>	1	-	527 005 410	118,60	B
	 <p>Pollen filter set for ComfoSpot 50, ISO Coarse $\geq 70\%$ / ISO ePM10 $\geq 60\%$ (G4 / F7) 10 pieces FIL-CSP50-CRS/G4-ePM10/F7-10PC</p>	1	-	527 005 420	130,10	B
ComfoAir 70						
	 <p>Filter set for ComfoAir 70, ISO Coarse $\geq 70\%$ (G4), 2 pieces FIL-CA70-CRS/G4-2PC-PCK</p>	1	-	527 005 180	30,98	B
	 <p>Pollen filter set for ComfoAir 70, ISO Coarse $\geq 70\%$ / ISO ePM10 $\geq 60\%$ (G4 / F7) 2 pieces FIL-CA70-CRS/G4-ePM10/F7-2PC-PCK</p>	1	-	527 005 190	34,15	B
	 <p>Filter set for ComfoAir 70, ISO Coarse $\geq 70\%$ (G4), 10 pieces FIL-CA70-CRS/G4-10PC</p>	1	-	527 005 160	128,60	B
	 <p>Pollen filter set for ComfoAir 70, ISO Coarse $\geq 70\%$ / ISO ePM10 $\geq 60\%$ (G4 / F7) 10 pieces FIL-CA70-CRS/G4-ePM10/F7-10PC</p>	1	-	527 005 170	138,20	B
ComfoAir 100, Ventos 50						
	 <p>Filter set for ComfoAir 100 / Ventos 50, ISO Coarse $\geq 70\%$ (G4) 2 pieces FIL-VEN-CA100-CRS/G4-2PC-PCK</p>	1	-	527 004 700	39,69	B
	 <p>Pollen filter for ComfoAir 100 / Ventos 50, ISO ePM2,5 $\geq 50\%$ (F7) 1 piece FIL-VEN-CA100-ePM2.5/F7-1PC</p>	1	-	524 000 020	29,90	B
ComfoAir 140						
	 <p>Pollen filter for ComfoAir 140, F6 1 piece FIL-L220-H187-F6</p>	1	50	006 040 160	38,22	B
ComfoAir 150, Multi 100 / 150						
	 <p>Filter set for ComfoAir 150 / Multi 100 / 150, ISO Coarse $\geq 70\%$ (G4) 2 pieces FIL-MUL100/150-CA150-CRS/G4-2PC-PCK</p>	1	-	527 004 690	38,60	B
	 <p>Pollen filter for ComfoAir 150 / Multi 100 / 150, ISO ePM2,5 $\geq 50\%$ (F7) 1 piece FIL-MUL100/150-CA150-ePM2.5/F7-1PC-PCK</p>	1	-	524 000 060	21,92	B

Replacement filters for ventilation units

Product	Description	PU 1	PU 2	Article no.	Gross price €	Discount group
ComfoAir flat 150, Climos 100 / 150						
	 Filter set for ComfoAir flat 150 Climos 100 / 150, G4, 2 pieces FIL-CLI100-CLI150-CAFL150-G4-2PC-PCK	1	-	527 004 670	38,60	B
	 Pollen filter for ComfoAir flat 150 Climos 100 / 150, F7, 1 piece FIL-CLI100-CLI150-CAFL150-F7-1PC-PCK	1	-	524 000 000	24,50	B
ComfoAir 160						
	 Filter set for ComfoAir 160, ISO Coarse $\geq 65\%$ (G4), 2 pieces FIL-CA160-SET-CRS/CRS	1	-	400 100 023	40,04	B
	 Pollen filter set for ComfoAir 160, ISO Coarse $\geq 65\%$ / ISO ePM1 $\geq 65\%$ (G4 / F7) 2 pieces FIL-CA160-SET-CRS/ePM1	1	-	400 100 024	42,52	B
Atmos 175, Thermos 200 / 300						
 	 Filter for Atmos 175, Thermos 200 / 300, ISO Coarse $\geq 55\%$ (G4), 1 piece FIL-ATM-THM-FB-EPP-DN160-CRS/G4-1PC	1	-	524 000 100	25,90	B
	 Pollen filter Atmos 175, Thermos 200 / 300, ISO ePM10 $\geq 60\%$ (F7), 1 piece FIL-ATM-THM-FB-EPP-DN160-ePM10/F7-1PC	1	-	524 000 090	31,30	B
	 Filter for Atmos 175 extract air (BF3), ISO Coarse $\geq 30\%$, 10 pieces FLE-ATM-CRS/G2-10PC-PCK	1	-	527 006 230	42,30	B
ComfoAir 180						
	 Filter set for ComfoAir 180, ISO Coarse $\geq 65\%$ (G4), 2 pieces FIL-CA180-SET-CRS/CRS	1	-	400 100 090	40,33	B
	 Pollen filter set for ComfoAir 180, ISO Coarse $\geq 65\%$ / ISO ePM1 $\geq 55\%$ (G4 / F7) 2 pieces FIL-SET-CA180-SET-CRS/EPM1	1	-	400 100 091	43,79	B
ComfoAir 200						
	 Filter set for ComfoAir 200, ISO Coarse $\geq 65\%$ (G4), 2 pieces FIL-PFR-L292-W24-H150-CRS-2pc	1	-	400 100 014	42,63	B
	 Pollen filter set for ComfoAir 200, ISO Coarse $\geq 65\%$ / ISO ePM1 $\geq 55\%$ (G4 / F7) 2 pieces FIL-PFR-L292-W24-H150-SET-CRS/ePM1	1	-	400 100 013	46,10	B
Climos 200						
	 Pollen filter set for Climos 200, ISO Coarse $\geq 75\%$ / ISO ePM1 60 % (M5 / F7) 2 pieces FIL-CLI200-CRS/M5-ePM1/F7-2PC-PCK	1	-	527 004 280	48,46	B
Focus 200						
	 Pollen filter set for Focus 200, ISO Coarse $\geq 70\%$ ISO ePM1 $\geq 60\%$ (G4 / F7), 2 pieces FIL-FCS-CCP-CRS/G4-ePM1/F7-2PC-PCK	1	-	527 003 430	47,60	B
	 Filter set for Focus 200, ISO Coarse $\geq 60\%$ 10 pieces FIL-FCS-CCP-ePM1/F7-10PC-PCK	1	-	527 009 750	220,04	B

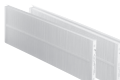
Replacement filters for ventilation units

Product	Description	PU 1	PU 2	Article no.	Gross price €	Discount group
Novus 300 / 450						
	 <p>Filter set for Novus 300 / 450, ISO Coarse ≥ 70 % (G4), 2 pieces FIL-NOV-CRS/G4-2PC-PCK</p>	1	-	527 004 250	49,10	B
	 <p>Filter set for Novus 300 / 450, ISO ePM10 60 % (F7), 10 pieces FIL-NOV-ePM1/F7-10PC-PCK</p>	1	-	527 009 740	257,20	B
ComfoAir G 90 / 91 / Santos 250						
 	 <p>Filter set for ComfoAir G 90 / 91, G3 (filter pad) 2 pieces FIL-L198-H465-<WK40/01-2pc</p>	1	25	006 040 104	7,96	B
	 <p>Filter set for ComfoAir G 90 / 91, Santos 250, G3 (bag filter), 2 pieces FIL-MFR-L198-H465->WK40/01-2pc</p>	1	25	006 040 102	18,35	B
	 <p>Filter set for ComfoAir 500 / 350, G3 (filter pad) 2 pieces FIL-L500-H198-G3-2pc</p>	1	25	006 040 120	15,58	B
ComfoAir 350 / 550, Santos 370 / 570						
 	 <p>Filter set for ComfoAir 350 / 550, Santos 370 / 570, ISO Coarse ≥ 60 % (G4) 2 pieces FIL-PFR-L500-W16.5-H197-SEL-CRS-2pc</p>	1	-	400 100 085	50,31	B
	 <p>Pollen filter set for ComfoAir 350 / 550, Santos 370 / 570, ISO Coarse ≥ 60 % / ISO ePM1 ≥ 50 % (G4 / F7) 2 pieces FIL-PFR-L500-W16.5-H197-SEL-CRS/ePM1</p>	1	-	400 100 084	53,37	B
	 <p>25 sets of filters coarse/ G4+ePM1/ F7 in 1 box, suitable for ComfoAir 350-450-550, ComfoD 350-450-550, ComfoFond-L ECO, box consists of 50 filters without manual FIL-CA350/450/550-SET-CRS/ePM1-PBG-25PCS</p>	1	-	400 100 116	1.155,40	B
ComfoAir Q350 / 450 / 600						
  	 <p>Filter set for ComfoAir Q350/450/600, ISO Coarse ≥ 65 % (G4), 2 pieces FIL-CAQ-CRS-2PC</p>	1	-	400 502 012	43,79	B
	 <p>Pollen filter set for ComfoAir Q350/450/600, ISO Coarse ≥ 65 % / ISO ePM1 ≥ 55 % (G4 / F7) 2 pieces FIL-CAQ-ePM1 / CRS</p>	1	-	400 502 013	46,10	B
	 <p>Filter set for ComfoAir Q350/450/600, ISO Coarse ≥ 65 % / Active coal ePM10, 2 pieces FIL-CAQ-1PC-AC-EPM10-1PC-CRS-PCK</p>	1	-	400 100 097	53,02	B
	 <p>Filter set for ComfoAir Q350/450/600, ISO Coarse ≥ 65 % (G4), 10 pieces FIL-CAQ-CRS-10PC</p>	1	-	400 502 014	197,04	B
	 <p>Pollen filter set for ComfoAir Q350/450/600, ISO Coarse ≥ 65 % / ISO ePM1 ≥ 55 % (G4 / F7) 10 pieces FIL-CAQ-ePM1-10PC</p>	1	-	400 502 015	217,81	B
	<p>30 sets of filters Coars/ G4 + epm1/ F7 in 1 box suitable for ComfoAir Q and ComfoAir E, box consists of 60 filters with manual FIL-CAQ-SET-CRS/CRS-PBG-30PCS</p>	1	-	400 100 118	1.089,30	B













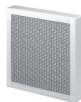

Replacement filters for ventilation units, outdoor air intake, filter box

Product	Description	PU 1	PU 2	Article no.	Gross price €	Discount group
ComfoAir Flex 250 / 350						
	 Filter set for ComfoAir Flex 250 / 350 ISO Coarse $\geq 65\%$ / ISO ePM1 $\geq 65\%$ (G4 / F7) FIL-CAF-ePM1/CRS	1	-	400 100 121	46,10	B
	 Filter set for ComfoAir Flex 250 / 350, ISO Coarse $\geq 65\%$ (G4), 2 pieces FIL-CAF-CRS-2PC	1	-	400 100 122	43,79	B
	 Filter set for ComfoAir Flex 250 / 350, ISO Coarse $\geq 65\%$ / ISO ePM1 $\geq 65\%$ (G4 / F7), 5 pieces FIL-CAF-ePM1-CRS-5PC	1	-	400 100 123	207,51	B
	 Filter set for ComfoAir Flex 250 / 350 ISO ePM1 $\geq 65\%$ (F7), 10 pieces FIL-CAF-ePM1-10PC	1	-	400 102 124	315,00	B
	 Filter set for ComfoAir Flex 250 / 350 ISO Coarse $\geq 65\%$ (G4), 10 pieces FIL-CAF-CRS-10PC	1	-	400 102 125	263,70	B
Kompakt 350						
	 Filter for Kompakt 350 extract air, ISO Coarse $\geq 55\%$ (G4), 1 piece FIL-ATM-THM-FB-EPP-DN160-CRS/G4-1PC	1	-	524 000 100	25,90	B
	 Filter for Kompakt 350 outdoor air, ISO Coarse $\geq 55\%$ (G4), 1 piece FIL-CAM-COMP350-CRS/G4-1PC-PCK	1	-	524 000 150	34,66	B
	 Pollen filter for Kompakt 350, ISO ePM10 $\geq 60\%$ (F7), 1 piece FIL-CAM-COMP350-ePM10/F7-1PC-PCK	1	-	524 000 140	47,30	B
Air intake tower 300						
	 Replacement filter for air intake tower 300, ISO Coarse $\geq 55\%$ (G4), 1 piece FIL-ATM-THM-FB-EPP-DN160-CRS/G4-1PC	1	-	524 000 100	25,90	B
	 Pollen filter for air intake tower 300, ISO ePM10 $\geq 60\%$ (F7), 1 piece FIL-ATM-THM-FB-EPP-DN160-ePM10/F7-1PC	1	-	524 000 090	31,30	B
Outdoor air filter box, type E						
	 Double-layer filter for outdoor air filter box type E, ISO Coarse $\geq 70\%$ (G2 / G4), 1 piece FIL-FB-EXR-SET-CRS/G2-CRS/G4-PCK	1	4	524 000 180	57,80	B
	 Double-layer filter for outdoor air filter box type E, ISO ePM2,5 $\geq 70\%$ (G2 / F7), 1 piece FIL-FB-EXR-SET-CRS/G2-ePM2.5/F7-PCK	1	-	524 000 170	65,20	B
Iso filter box DN 125						
	 Filter for iso filter box DN 125, ISO Coarse $\geq 75\%$ (M5), 1 piece FIL-CLI200-FB-EPP-DN125-CRS/M5-1PC-PCK	1	-	521 013 080	22,79	B
	 Pollen filter for iso filter box DN 125, ISO ePM1 $\geq 60\%$ (F7), 1 piece FIL-CLI200-FB-EPP-DN125-ePM1/F7-1PC-PCK	1	-	521 012 720	29,70	B
	 Active carbon filter for iso filter box DN 125, type AK, 1 piece FIL-FB-EPP-DN125-AC-1PC	1	-	521 014 090	52,10	B

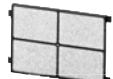
Replacement filters for filter box

Product		Description	PU 1	PU 2	Article no.	Gross price €	Discount group
Pollen filter housing DN 150 / 160							
		Pollen filter for pollen filter housing DN 150 / 160, F7 dimensions 287 x 287 x 44 mm 1 piece FIL-F7-L287-W44-H287	1	-	990 316 102	71,10	B
Filter box DN 160							
		Filter for filter box DN 160, ISO Coarse ≥ 70% (G3) 1 piece FIL-FB-PRH-EPP-DN160-CRS/G3-1PC	1	-	524 000 810	25,67	B
		Filter for filter box DN 160, ISO Coarse ≥ 55% (G4) 1 piece FIL-ATM-THM-FB-EPP-DN160-CRS/G4-1PC	1	-	524 000 100	25,90	B
		Pollen filter for filter box DN 160, ISO ePM10 ≥ 60% (F7) 1 piece FIL-ATM-THM-FB-EPP-DN160-ePM10/F7-1PC	1	-	524 000 090	31,30	B
		Pollen filter for filter box DN 160, H10 1 piece FIL-FB-EPP-DN160-ePM1/H10-1PC	1	-	524 000 910	114,10	B
		Active carbon filter for filter box DN 160, type AL (smoke, flue gases) 1 piece FIL-FB-EPP-DN160-AC/K-1PC	1	-	524 000 080	72,29	B
		Active carbon filter for filter box DN 160, type AL (agricultural odours) 1 piece FIL-FB-EPP-DN160-AC/L-1PC	1	-	524 000 920	94,50	B
Pollen filter housing DN 180							
		Pollen filter for pollen filter housing DN 180, F7 dimensions 287 x 287 x 94 mm 1 piece FIL-F7-L287-W94-H287	1	24	990 316 103	100,10	B

Replacement filters for heating elements, brine-earth heat exchangers, air distribution

Product	Description	PU 1	PU 2	Article no.	Gross price €	Discount group		
Iso defroster box DN 160								
	 Filter for iso defroster DN 160, ISO Coarse \geq 70% (G3) 1 piece FIL-FB-PRH-EPP-DN160-CRS/G3-1PC	1	-	524 000 810	25,90	B		
ComfoFond-L 300 / 600								
	 Filter for ComfoFond-L 300 / 600, G4 dimensions: 287 x 287 x 48 mm 1 piece FIL-PFR-L287-W27-H48-CRS-PBG	1	24	400 100 060	82,60	B		
ComfoFond-L Eco 350 / 550								
	 Filter for ComfoFond-L Eco 350 / 550, ISO Coarse \geq 60 % (G4), 1 piece suitable for ComfoFond-L Eco 471310012, 471310017, 471310022, 471310027, 471310070, 471310071, 471310080 and 471310081 FIL-PFR-L500-H197-CRS-PCK	1	-	400 100 065	28,70	B		
	 Filter for ComfoFond-L Eco 350 / 550 and ComfoFond-L Q, ISO Coarse \geq 60 % (G4) 1 piece suitable for ComfoFond-L Eco 471310013, 471310018, 471310023, 471310028 and ComfoFond-L Q FIL-CRS-SPR-P	1	-	400 100 066	28,70	B		
Air distribution								
	 Replacement filter for extract air housing 990 220 010, ISO Coarse \geq 45 % (G3) 10 pieces FIL-CLD-L230-W110-CRS-45%-10PC	1	10	990 320 030	28,70	B		
	 Replacement filter for extract air housing CLD, ISO Coarse \geq 45 % (G3) 10 pieces FIL-CLD-L158-W113-H9-CRS-45%-10PC-WHITE	1	540	990 320 575	89,60	B		
		Filter set DN 100, ISO Coarse \geq 45 % (G3) suitable for Luna E125, extract valves and designer grills 10 pieces FIL-DIV-DN100-CRS-45%-10PC		1	20	990 320 031	30,10	B
		Filter set DN 125, ISO Coarse \geq 45 % (G3) suitable for extract air valves and designer grilles CLR / TVA 10 pieces FIL-DIV-DN125-CRS-45%-10PC		1	20	990 320 032	33,10	B
	 Filter set CLF, ISO Coarse \geq 30 % 10 pieces FIL-CLF-L295-W75-CRS-30%-10PC	1	70	990 322 100	78,20	B		

Replacement filters for ComfoWell

Product	Description	PU 1	PU 2	Article no.	Gross price €	Discount group
	Fine dust filters and active carbon filters for installing in filter housing Fine dust filter CW 220-PM1-75% dimensions: 200 x 225 x 48 (L x W x D), filter ISO ePM1 ≥ 75% (F7) FIL-CW220-PM1-75%	1	108	990 323 600	59,50	B
	Fine dust filter CW 320-PM1-75% dimensions: 300 x 225 x 48 (L x W x D), filter ISO ePM1 ≥ 75% (F7) FIL-CW320-PM1-75%	1	72	990 323 603	67,70	B
	Fine dust filter CW 420-PM1-75% dimensions: 2 pieces, each 200 x 225 x 48 (L x W x D), filter ISO ePM1 ≥ 75% (F7) FIL-CW420-PM1-75%	1	-	990 323 650	78,90	B
	Fine dust filter CW 520-PM1-75% dimensions: 500 x 225 x 48 (L x W x D), filter ISO ePM1 ≥ 75% (F7) FIL-CW520-PM1-75%	1	48	990 323 606	90,10	B
	Fine dust filter CW 625-PM1-75% dimensions: 2 pieces, each 300 x 225 x 48 (L x W x D), filter ISO ePM1 ≥ 75% (F7) FIL-CW625-PM1-75%	1	-	990 323 653	101,50	B
	Fine dust filter CW 220-PM1-90% dimensions: 200 x 225 x 48 (L x W x D), filter ISO ePM1 ≥ 90 % (F9) FIL-CW220-PM1-90%	1	108	990 323 601	54,18	B
	Fine dust filter CW 320-PM1-90% dimensions: 300 x 225 x 48 (L x W x D), filter ISO ePM1 ≥ 90 % (F9) FIL-CW320-PM1-90%	1	72	990 323 604	59,94	B
	Fine dust filter CW 420-PM1-90% dimensions: 2 pieces, each 200 x 225 x 48 (L x W x D), filter ISO ePM1 ≥ 90 % (F9) FIL-CW420-PM1-90%	1	-	990 323 651	76,04	B
	Fine dust filter CW 520-PM1-90% dimensions: 500 x 225 x 48 (L x W x D), filter ISO ePM1 ≥ 90 % (F9) FIL-CW520-PM1-90%	1	48	990 323 607	80,13	B
	Fine dust filter CW 625-PM1-90% dimensions: 2 pieces, each 300 x 225 x 48 (L x W x D), filter ISO ePM1 ≥ 90 % (F9) FIL-CW625-PM1-90%	1	-	990 323 654	92,25	B
	Active carbon filter CW-FC 220 dimensions: 200 x 225 x 96 (L x W x D) FIL-CW220-AC	1	54	990 323 602	39,92	B
	Active carbon filter CW-FC 320 dimensions: 300 x 225 x 96 (L x W x D) FIL-CW320-AC	1	36	990 323 605	46,33	B
	Active carbon filter CW-FC 420 dimensions: 2 pieces, each 200 x 225 x 96 (L x W x D) FIL-CW420-AC	1	-	990 323 652	56,88	B
	Active carbon filter CW-FC 520 dimensions: 500 x 225 x 96 (L x W x D) FIL-CW520-AC	1	24	990 323 608	67,15	B
	Active carbon filter CW-FC 625 dimensions: 2 pieces, each 300 x 225 x 96 (L x W x D) FIL-CW625-AC	1	6	990 323 655	76,04	B

Notes

A large grid of small dots for taking notes, covering most of the page.

always the best climate

Zehnder Group ▪ Sales EMEA East ▪ emea.east@zehndergroup.com

HUNGARY:

Gyár u. 2 ▪ 2040 Budaörs ▪ Hungary

T +36 30 460 2490 ▪ info@zehnder.hu ▪ www.zehnder.hu

OFFICE ROMANIA:

T +40 721 758 870 ▪ info@zehnder-systems.ro ▪ www.international.zehnder-systems.com